

SCC

Please connect the battery first, and then connect the solar panel after setting the system parameters. If you do not operate in order, the battery will be damaged.



MPPT

User's manual

12V/24V/48V Auto. (36V)

Catalogue

※	Focus	1P-2P	※
	Product instructions	3P-12P	
	System voltage setting	P9	
	Battery type setting	P9	
	Load working mode	P10	
	Detailed parameters	P12	
	APP download(Optional)	P13	
	APP connection(Optional)	P13	



When using lithium batteries, please set the system voltage first, and then set the corresponding battery type(See P9-4.2 / P9-4.3 for more details)

1. Wiring Instruction

Solar energy system wiring diagram

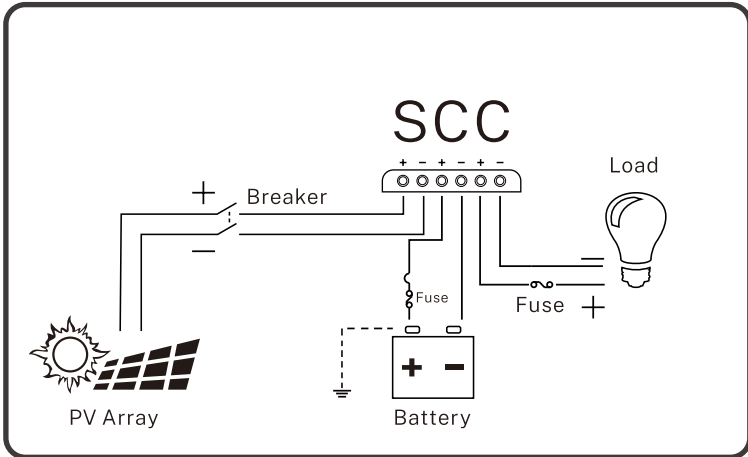

❌ Wrong cable connections may damage the controller

❌ Perform the following steps to connect cables and install them ❌

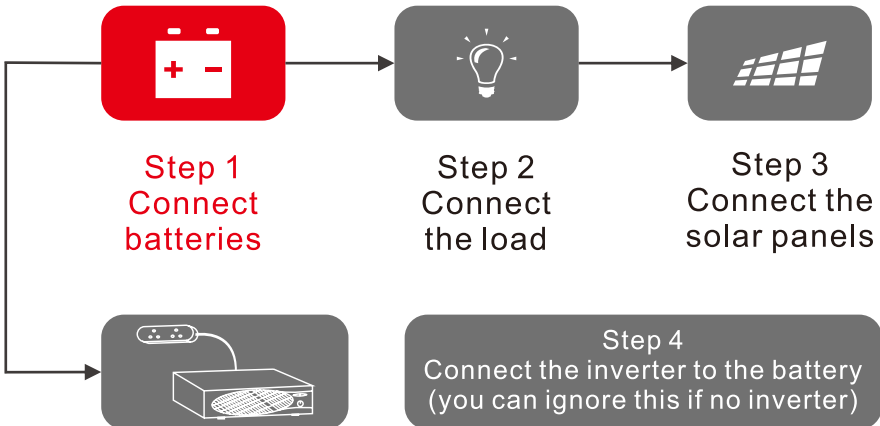

When disassembling, refer to the above order to complete the reverse

2.Notice



This series of MPPT is a common positive controller, PV array, battery and load of the positive pole can be grounded at the same time.



If the inverter or other starting current is loaded in the system, please connect the inverter directly to the battery. Do not connect with the controller's load terminal



If you use lithium batteries, set the corresponding battery type before using them.
(For details, see P8-4.1 / P9-4.2)

3.Screen display

3.1 Icon Meaning

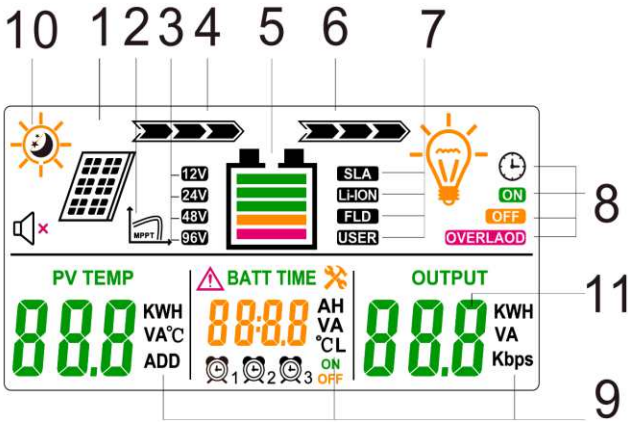

- 1 Solar Panel
- 2 Working Status
- 3 System Voltage
- 4 Charge Display
- 5 Battery Capacity
- 6 Discharge Display

- Battery Type 7
- load working mode & status 8
- Parameters Unit 9
- Day Or Night 10
- Parameters Display 11

3.2 Button definition

Button meaning	Button pattern	Button function
MENU		Press and hold to enter or exit the settings screen. Short press to confirm; Load switch;
FORWARD		Loop the page forward
BACKWARD		Loop the page backwards

3.3 start up interface

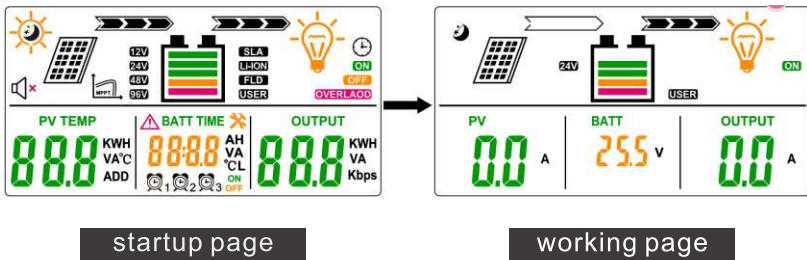

- (1)Startup page:Boot interface
- (2)Working page: By pressing bottom "M" to switch load on/off .
The battery is properly connected to the controller,rated charging and discha-rging current, battery voltage, system voltage, battery type etc. can be checked in this page.

3.4 LCD main interface display

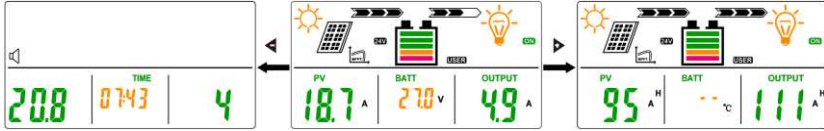

By pressing "-" or "+" to circulate interfaces. it will switch automatically to fault interface after 15S if something is out of work. By pressing "-" or "+" to cancel "error code" interface.

Notice:

below situation valid only for products with loading control function.

3.5 View the PV input voltage

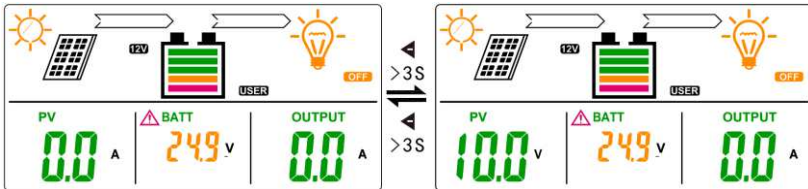

By long pressing "-" over 3S to check PV input voltage value.

3.6 time setting

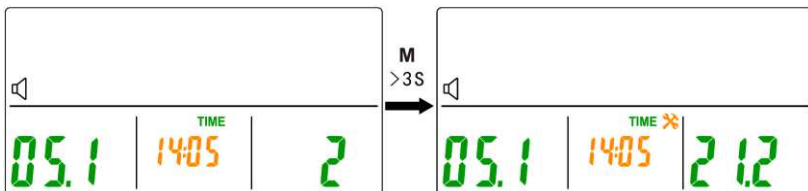

By long pressing "M" over 3S to set real time clock and date. Above screen from left to right, it means Day,Month,Hour,Minute,Year and week.

Notice: for month display, O means Oct., N means Nov., D means Dec.

3.7 Cumulative charge and discharge display

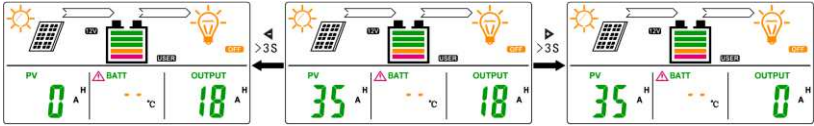

After the cumulative charge and discharge reaches 65KAH, the system accumulates again(You can hold down "-" to manually reset).

3.8 Adjustment of sound volume

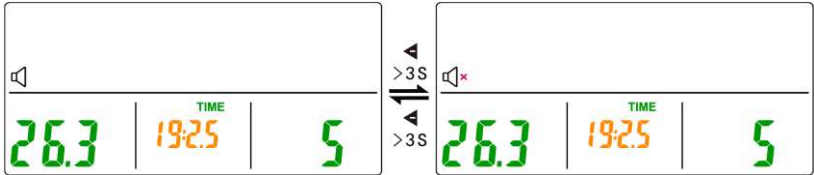

Press and hold "-" to adjust the volume.

3.9 Restore factory setting

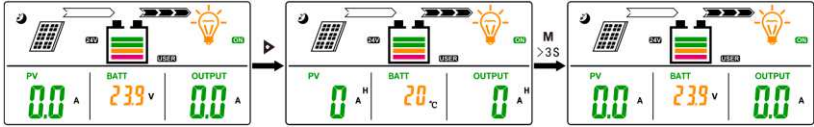

Press the button "+" to second page and long press button "M" to restore factory settings.

4. Page introduction

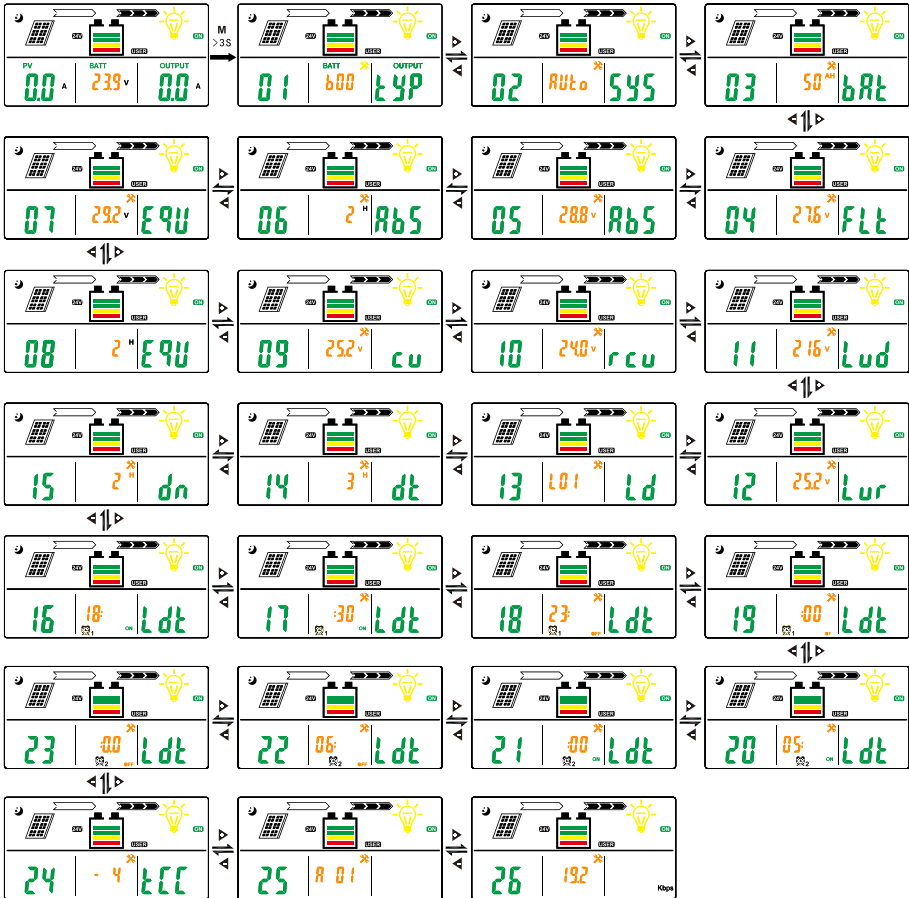

Loop main interface description(27 pages in total)

00	Work page (home page)	Lithium battery recover charging voltage(RCV)	10
01	Battery type	The battery will stop working if the voltage is too low	11
02	System voltage	Battery low volt. recovery charging	12
03	Battery capacity	Load working mode	13
04	Floating charge voltage	Load after dark working hours set	14
05	Absorption charge voltage	Load before dawn working hours set	15
06	Absorption charge time	Load time control and time setting	16-23
07	Equalizing charge voltage	Temperature compensation coefficient	24
08	Equalizing charging time	Communication Address Setting	25
09	Constant voltage charge of lithium battery(CV)	Serial port communication baud rate set	26

4.1 Battery type setting method

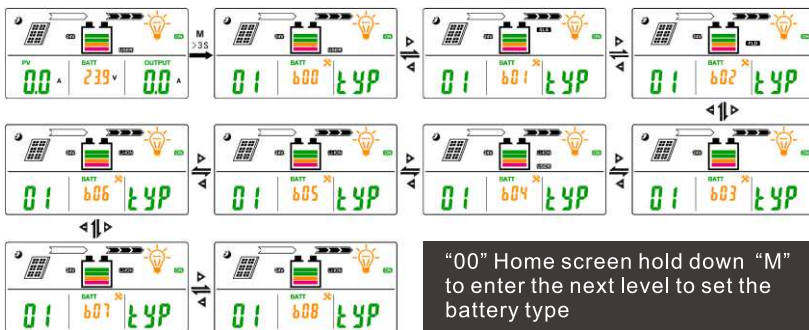

“00” Home screen hold down “M” to enter the next level to set the battery type

4.2 System battery voltage setting

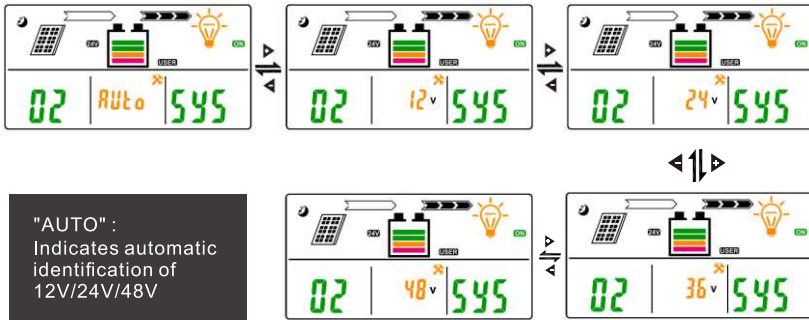

On the screen "02", press "M" to enter the next level and set the system battery voltage.

✘ 36V is not automatically recognized and can be set as a fixed system voltage.

4.3 Battery type code meaning

Battery type symbol	Type meaning
B00	Lead-acid custom
B01	Sealed battery
B02	Flooded battery
B03	Gel battery
B04	Lithium battery customization
B05	3.2V-4 series of LiFePO4
B06	3.2V-5 series of LiFePO4
B07	3.7V-3 series polymer lithium battery
B08	3.7V-4 series polymer lithium battery

※ B04:Lithium battery User-defined type

In lithium battery custom mode, manual operation is required, Set constant charge voltage (CV)

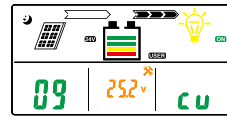

Page 09

In lithium battery custom mode, The recovery charging voltage needs to be set manually.(CVR)

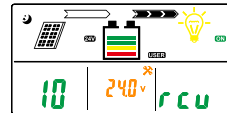

Page 10

※ Lead-acid batteries do not support constant voltage charging(CV)

4.4 Set the load working mode

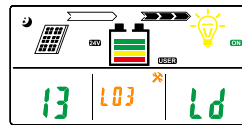
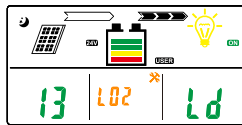
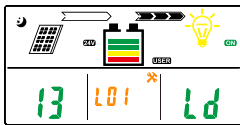

Press "M" on the interface "13" to enter the next level and set the load working mode

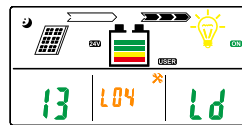
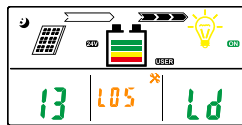
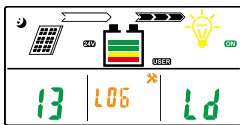

- L01:Regular mode(The load continues working for 24hs a day)
- L02:Light control mode(The load works only at night)
- L03:Reverse light control mode(The load works only during the day)
- L04:Dual time control mode(light control first)
- L05:Time control mode(Set load works time)
- L06:Charge only mode(charge-only)

4.5 Serial port communication baud rate setting

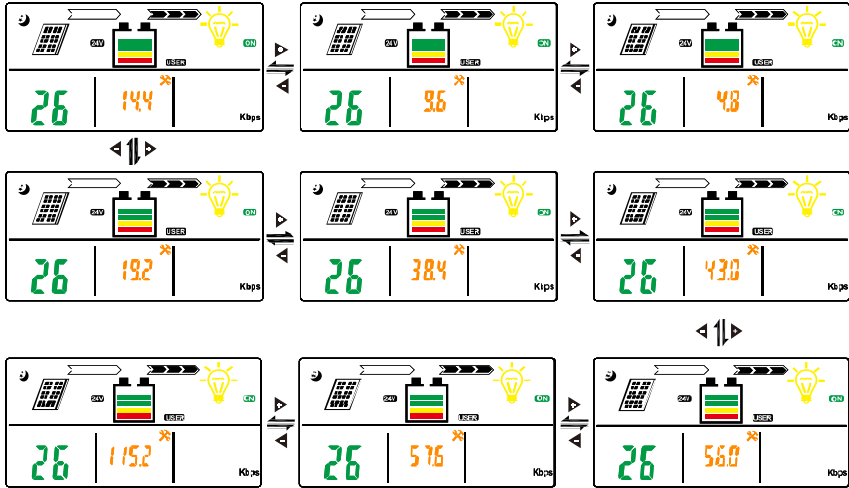

Press "M" on screen "26" to go to the next level and set the baud rate.

5. Fault code

Error code	Reason	Controller status	Solution
Ex1	Battery over discharge	1. Battery voltage is less than 10.8v 2. Loads will be disconnected	Charge the battery
Ex2	Battery over voltage	Loads will be disconnected and battery charging will automatically stop	Check whether the system voltage matches the battery voltage; Ensure that the high voltage disconnect voltage does not exceed the battery voltage and reconnect the PV
Ex3	Over load	If discharging current is 1.2times the rated controller's current, the load will disconnect automatically after 60s, if 1.5 times, the load will disconnect after 10s. The load work after 6mins	Reduce the load output, and switch on load manually or wait 6 minutes for autoswitch-on by controller
Ex5	PV input over voltage protection	When PV Input voltage exceeds 149v, battery charging will stop	Battery charging will recover when PV input voltage is below 146v.
Ex6	Controller overheating	The controller will stop charging when it's temperature exceeds 88 °C and restart to work when it's temperature is below 75 °C	Cool down the controller.
Ex7	Internal temperature sensor doesn't work	The controller will work normally	
Ex8	Controller will restart after setting system voltage		Disconnect PV array first and disconnect battery Power on again.

"E" stands for "Error";
 "X" indicates the number of errors. If there are multiple errors, press "+" or "-" to check the loop.
 "1-8" indicates the code name.

6. Technical parameter

Input									
Maximum PV open circuit voltage	150V (at the lowest temperature) 138V (at a standard temperature of 25°)								
Minimum PV voltage	20V/40V/60V/80V								
Rated Charge Current	10A	20A	30A	40A	50A	60A	80A	100A	
Maximum input power	12V	130W	260W	390W	520W	650W	780W	1040W	1300W
	24V	260W	520W	780W	1040W	1300W	1560W	2080W	2600W
	36V	390W	780W	1170W	1560W	1950W	2340W	3120W	3900W
	48V	520W	1040W	1560W	2080W	2600W	3120W	4160W	5200W
Output									
System voltage	12V/24V/36V/48V Auto								
Rated Discharge Current	10A	10A	20A	20A	30A	30A	40A	40A	
Self-consume	≤35mA(48V)								
MPPT highest accuracy	99%								
Maximum charging efficiency	97%								
Charging control mode	Multi-stage(MPPT, Absorption, Float, Equalization, CV)								
Float charge	13.8V/27.6V/41.4V/55.2V								
Boost charge	14.4V/28.8V/43.2V/57.6V								
Equalization charge	14.6V/29.2V/43.8V/58.4V								
Low voltage disconnect voltage	10.8V/21.6V/32.4V/43.2V								
Low voltage recovery voltage	12.6V/25.2V/37.8V/50.4V								
Load control mode	Normal, light control, light and timing control, timing control, reverse light control								
Light control point voltage	5V/10V/15V/20V								
Battery Type	GEL, SLD, FLD and USR(default), Lithium batteries customization 3series 3.7V, 4 series 3.7V, 4series 3.2V, 5series 3.2V								
Other									
Human interface	Color LCD with backlight, 3 buttons								
Cooling mode	Iron case heat sink and cooling fan								
Wiring	High current copper terminals ≤25 mm ² (3AWG)								
Temperature probe	10K, line length 3 meters								
Communication mode	RS485, RJ45 port								
Working temperature range	-20~+55° C								
Storage temperature range	-30~+80° C								
Humidity	10%~90% No condensation								

Notice

Please operate at the ambient temperature allowed by the controller.
If the ambient temperature exceeds the allowable range of the controller, please derate it

7.APP download(optional)



Scan QR code to download APP

8.APP Connection(optional)

2. Click "+" to search for products

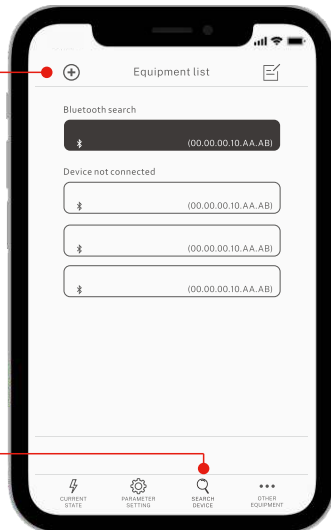

1. Select the Device Search screen

SCC

MPPT

User's manual