

INSTRUCTION MANUAL

Model. No. JW-C4BF Catalogue no: ME-103DC

READ AND SAVE THESE INSTRUCTIONS

Please read the following instructions carefully and retain a copy of this information for future reference. When using this electrical appliance, the following safety precautions should be strictly followed.

Simple Introduction

This product adopts the direct current frequency converted motor that is high efficiency, saving, durable and environmental protection

Caution

1. This product is with input voltage: DC 12v.
2. If you or familiar with electrical installation, be sure have a licensed electrician to install the product for you.
3. when installing a ceiling fan, all parts with screws must be tightened Firmly
4. Choose a location for mounting the fan where the blades will be clear from all obstructions and maintain a minimum of 2.3 meters from the floor

Installation preparation tool

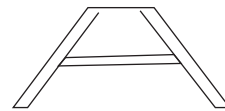
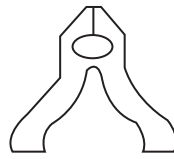
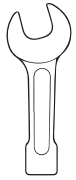

10# Spanner Slotted screwdriver philips screwdriver plastic clamp

ladder

Setup Details of parts

- | | |
|--------------------|-----------------|
| 1. Motor | 4. Downrod |
| 2. Blade | 5. Bracket |
| 3. Screw for blade | 6. Wall control |

1. Minimum space for Installation (see Fig 1)

2. Bracket installation

For wooden ceiling, the brackets should be fixed on the beam by 1.5 inches wooden threaded screw! (see Fig 2)

For the cement ceiling, firstly use with $\varnothing 8$ mm impact drilling bit to drill a hole to fit the expansion screw than secure the bracket on the ceiling by tightening M6 expansion screw see Fig 3)

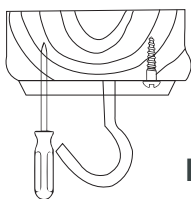

Fig 2

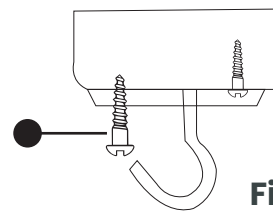

Fig 3

Note: after the bracket is secured, must ensure the selected ceiling location with the fixings are capable of supporting a minimum weight/gravity of 60 Kgs (use hand try to pull the bracket for safety assurance).

Note, please pay attention to different materials of ceiling and select the appropriate type of screws to fix the bracket. Do not Fix the bracket directly on the plywood to avoid screw loosening that causes danger.

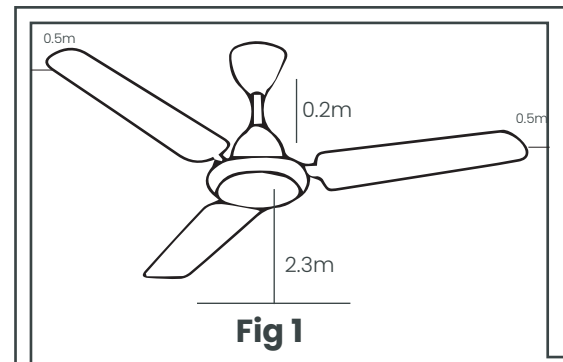

Fig 1



Visit Our Website
www.maxima.solar



Call Us
+971 4 2231185



Our Address
Shop 5&6, 7 States building Baniyas
Square, Deira, Dubai, UAE

3. Blades Installation

Secure fan blades using screw by Philips screwdriver until tightened if on the motor cover. (see Fig 4)

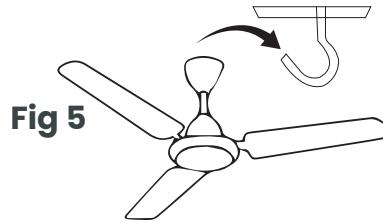
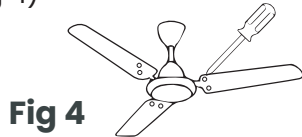

4. Fix the fan to the bracket

Place the ceiling fan to the bracket (see fig 5)

5. Wires connection

1. According to the label on terminal block, connect the + polarity wire and -polarity wire. Make sure the secured screws are tightened firmly.

Wires should not be loosed. (see fig6)

Slide the upper conopy to the ceiling, lighten the screw. (see figure 7)

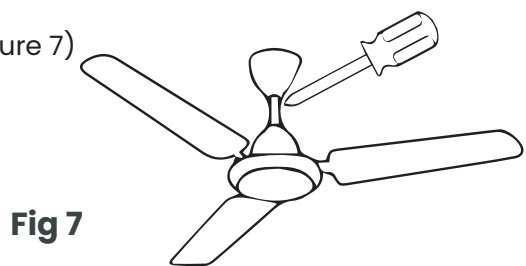
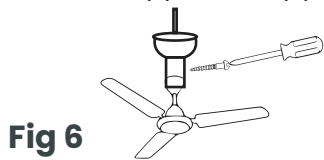

6. Wall control installation

Drill the holes and stuff plastic stopper on the wall, use the self-tapped screw to fix the wall control on the wall. <see fig8>

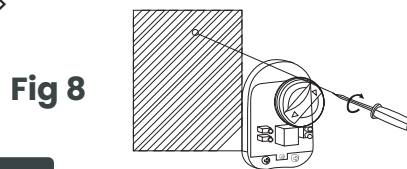

7. Wall control wires connection

According to the label on terminal block, OUTPUT terminal block-make connection to the motor + polarity + wire and aslo -polarity-wire. INPUT terminal block -make connection to the DC12V power supply input + polarity + wire and also - polarity-wire. Note: OUTPUT INPUT power supply polarity must not be wrongly connected. Careful conection must be taken. <see fig9>

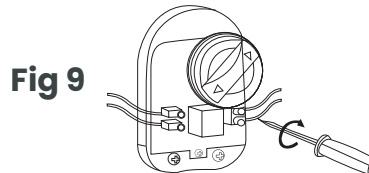

FAN FUNCTION

1/2/3 (speed)

Speed is the lowest and 2/3 is gradually increased air flow. Speed is the highest

Trouble Shooting

Problems	Solutions
Motor cannot work	Ensure the supply cables have been well connected, you should focus on checking the wires connection of the + and - polarity in correct match.
	Check the nput voltage is DC 12V, if it is too low. the motor cannot be started. Too high, it will bring harmful effects to the motor.
	Note: if you fail to overcome the above failures, do not make attempt to open the motor cover for repair. You should contact the qualified electrician to fix it
Fan vibration	Ensure the fan-blades have beer firmly secured in place. Ensure the position of each blade be aligned with each other. Ensure the mounting screws are firmly tightened.

Wiring diagram.

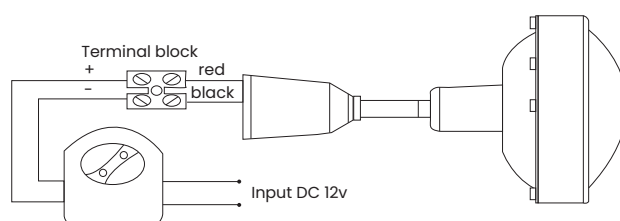

Ref: ME 103DC/20141222



Visit Our Website
www.maxima.solar



Call Us
+971 4 2231185



Our Address
Shop 5&6, 7 States building Baniyas
Square, Deira, Dubai, UAE