

User Manual

Hybrid 30KW PV Inverter

Version: 1.2

Table Of Contents

1.	Introduction	1
2.	Important Safety Warning.....	2
3.	Unpacking & Overview	4
	3-1. Packing List.....	4
	3-2. Product Overview	4
4.	Installation	5
	4-1. Selecting Mounting Location	5
	4-2. Unit Installation.....	5
	4-3. Unpack the unit.....	6
5.	Grid (Utility) Connection	7
	5-1. Preparation	7
	5-2. Connecting to the AC Utility.....	7
6.	PV Module (DC) Connection	8
7.	Battery Connection.....	9
8.	Load (AC Output) Connection.....	10
9.	Communication.....	12
	9.1. Serial Communication & Intelligent Slot	12
	9.2. Dry Contact.....	12
10.	Commissioning	14
11.	Initial Setup.....	15
12.	Operation	25
	12.1 Control Panel.....	25
	12.2. LCD Information.....	26
	12.3. Sub-menus	28
	12.4. Operation Mode & Display	40
13.	Charging Management	45
14.	Maintenance & Cleaning	46
15.	Trouble Shooting.....	47
	15.1. Warning List	47
	15.2. Fault Reference Codes.....	48
16.	Specifications	51
17.	Parallel Function	53

1. Introduction

This hybrid PV inverter can provide power to connected loads by utilizing PV power, utility power and battery power.

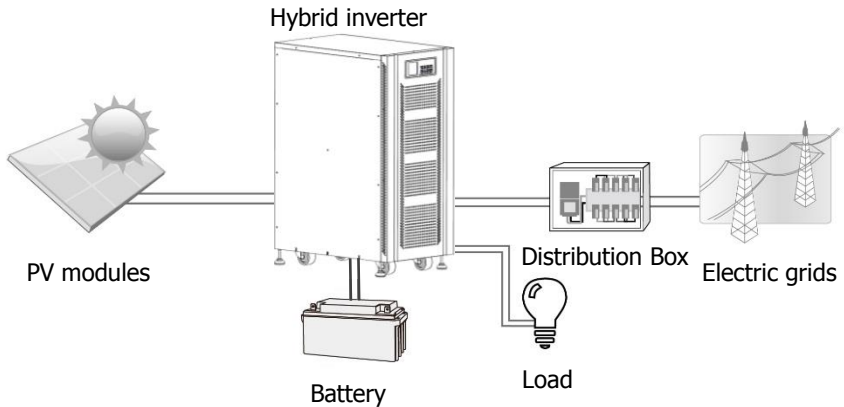

Figure 1 Basic hybrid PV System Overview

Depending on different power situations, this hybrid inverter is designed to generate continuous power from PV modules (solar panels), battery, and the utility. When MPP input voltage of PV modules is within acceptable range (see specification for the details), this inverter is able to generate power to feed the grid (utility) and charge battery. See Figure 1 for a simple diagram of a typical solar system with this hybrid inverter.

2. Important Safety Warning

Before using the inverter, please read all instructions and cautionary markings on the unit and this manual. Store the manual where it can be accessed easily.

This manual is for qualified personnel. The tasks described in this manual may be performed by qualified personnel only.

General Precaution-

Conventions used:

WARNING! Warnings identify conditions or practices that could result in personal injury;

CAUTION! Caution identify conditions or practices that could result in damaged to the unit or other equipment connected.



WARNING! Before installing and using this inverter, read all instructions and cautionary markings on the inverter and all appropriate sections of this guide.



WARNING! Normally grounded conductors may be ungrounded and energized when a ground fault is indicated.



WARNING! This inverter is heavy. It should be lifted by at least two persons.



CAUTION! Authorized service personnel should reduce the risk of electrical shock by disconnecting AC, DC and battery power from the inverter before attempting any maintenance or cleaning or working on any circuits connected to the inverter. Turning off controls will not reduce this risk. Internal capacitors can remain charged for 5 minutes after disconnecting all sources of power.



CAUTION! Do not disassemble this inverter yourself. It contains no user-serviceable parts. Attempt to service this inverter yourself may cause a risk of electrical shock or fire and will void the warranty from the manufacturer.



CAUTION! To avoid a risk of fire and electric shock, make sure that existing wiring is in good condition and that the wire is not undersized. Do not operate the Inverter with damaged or substandard wiring.



CAUTION! Under high temperature environment, the cover of this inverter could be hot enough to cause skin burns if accidentally touched. Ensure that this inverter is away from normal traffic areas.



CAUTION! Use only recommended accessories from installer. Otherwise, not-qualified tools may cause a risk of fire, electric shock, or injury to persons.



CAUTION! To reduce risk of fire hazard, do not cover or obstruct the cooling fan.



CAUTION! Do not operate the Inverter if it has received a sharp blow, been dropped, or otherwise damaged in any way. If the Inverter is damaged, please call for an RMA (Return Material Authorization).



CAUTION! AC breaker, DC switch and Battery circuit breaker are used as disconnect devices and these disconnect devices shall be easily accessible.

Symbols used in Equipment Markings

	Refer to the operating instructions
	Caution! Risk of danger
	Caution! Risk of electric shock
	Caution! Risk of electric shock. Energy storage timed discharge for 5 minutes.
	Caution! Hot surface

3. Unpacking & Overview

3-1. Packing List

Before installation, please inspect the unit. Be sure that nothing inside the package is damaged. You should have received the following items inside of package:



3-2. Product Overview

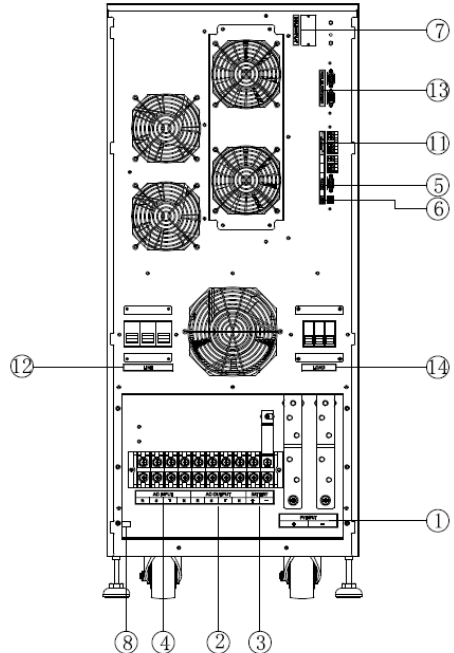
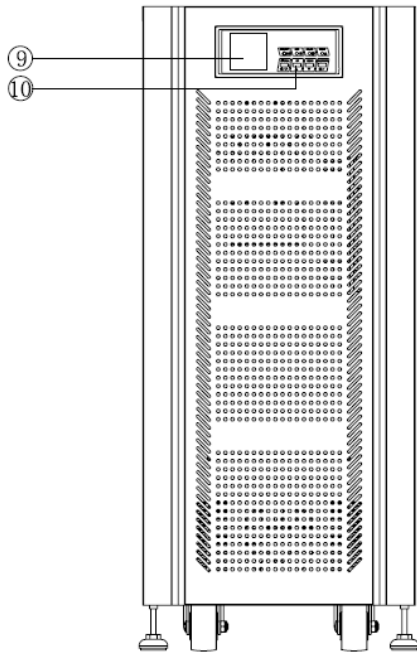

- | | |
|------------------------------|------------------------------|
| 1) PV connectors | 9) LCD display panel |
| 2) AC output connectors | 10) Operation buttons |
| 3) Battery connectors | 11) Reserved for dry contact |
| 4) AC input connectors | 12) AC input breaker |
| 5) RS-232 communication port | 13) Parallel ports |
| 6) USB communication port | 14) AC output breaker |
| 7) Intelligent slot | |
| 8) Grounding | |

4. Installation

4-1. Selecting Mounting Location

Consider the following points before selecting where to install:

- Do not mount the inverter on flammable construction materials.
- This inverter can make noises during operation which may be perceived as a nuisance in a living area.
- For proper air circulation to dissipate heat, allow a clearance of approx. 50 cm to the side and approx. 80 cm to front and back the unit.
- Dusty conditions on the unit may impair the performance of this inverter.
- The ambient temperature should be between 0°C and 55°C and relative humidity should be between 5% and 85% to ensure optimal operation.
- For proper operation of this inverter, please use appropriate cables for grid connection.
- The pollution degree of the inverter is PD2. Select an appropriate mounting location. Install the solar inverter in a protected area that is dry, free of excessive dust and has adequate air flow. Do NOT operate it where the temperature and humidity is beyond the specific limits. (Please check the specs for the limitations.)
- Installation position shall not prevent access to the disconnection means.
- This inverter is designed with IP20 for indoor applications only.
- Regularly clean the fan filter.

4-2. Unit Installation

WARNING!! Remember that this inverter is heavy! Please be carefully when lifting out from the package.

The inverter only can be used in a CLOSED ELECTRICAL OPERATING AREA. Only service person can enter into this area.

Consider the following points before selecting where to install:

- Do not mount the inverter on flammable construction materials.
- It's requested to have a clearance of approx. 80 cm to the front and back of the unit and approx. 50 cm to the side.
- Dusty conditions on the unit may impair the performance of this inverter.
- The ambient temperature should be between 0°C and 55°C to ensure optimal operation.
- For proper operation, please use appropriate cables.

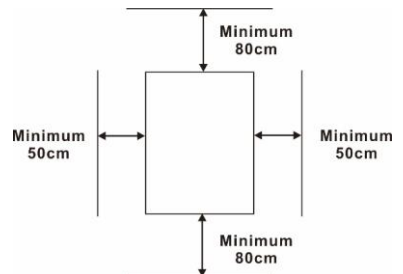

WARNING!! FIRE HAZARD.
SUITABLE FOR MOUNTING ON CONCRETE OR OTHER NON-COMBUSTIBLE SURFACE
ONLY.

4-3. Unpack the unit

Then, follow below steps to remove the UPS from the carton and pallet.

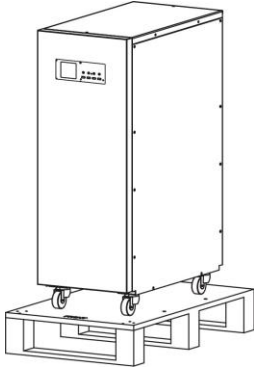

Step 1: Remove carton and foams

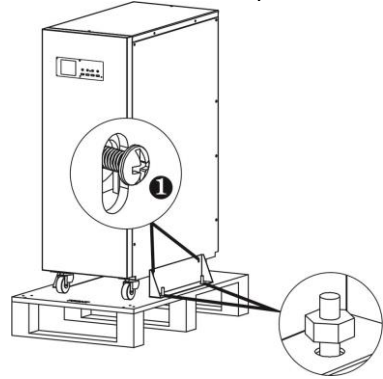

Step 2: Remove fixing plates on the two sides of the inverter as shown in the chart. After removing fixing plates, please put #1 screws back to inverter.

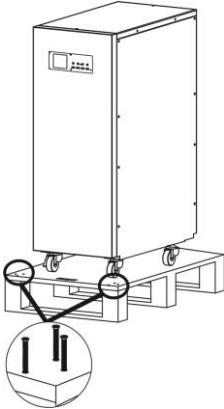

Step 3: Take off front foot of the pallet by removing screws as shown in chart.

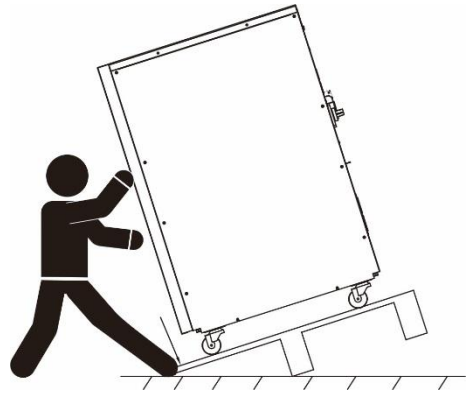

Step 4: Then, lean the pallet to remove the inverter from the pallet.

NOTE: Before installation, please inspect the unit. Be sure that nothing inside the package is damaged during transportation. Do not turn on the unit and notify the carrier and dealer immediately if there is any damage or lacking of some parts. Please keep the original package in a safe place for future use.

5. Grid (Utility) Connection

5-1. Preparation

Before connecting to AC utility, please install a **separate** AC circuit breaker between inverter and AC utility. This will ensure the inverter can be securely disconnected during maintenance and fully protected from over current of AC input.

NOTE1: The overvoltage category of the AC input is III. It should be connected to the power distribution.

WARNING! It's very important for system safety and efficient operation to use appropriate cable for grid (utility) connection. To reduce risk of injury, please use the proper recommended cable size for AC wire as below.

Nominal Grid Voltage	230VAC
Conductor cross-section (mm ²)	8
AWG no.	8

5-2. Connecting to the AC Utility

Please follow below steps to implement AC input connection:

1. Before making AC input/output connection, be sure to open DC protector or disconnecter first.
2. Remove insulation sleeve 12 mm and insert conductor into cable ring terminal. Refer to right chart.

Ring terminal:

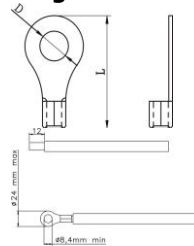

Recommended wire and terminal size:

Wire Size	Ring Terminal			Torque value
	Cable mm ²	Dimensions		
		D (mm)	L (mm)	
8 AWG	8	8.4	29	12.0 Nm

3. Insert AC input wires according to polarities indicated on terminal block and tighten the terminal screws. Be sure to connect PE protective conductor (⊕) first.

⊕ → **Ground (yellow-green)**

R Phase → **LINE (black)**

Y Phase → **LINE (gray)**

B Phase → **LINE (brown)**

N → **Neutral (blue)**

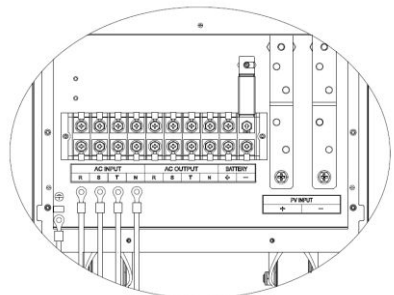

Note: For safe operation, please use one more

CAUTION: To prevent risk of electric shock, ensure the ground wire is properly earthed before operating this hybrid inverter no matter the grid is connected or not.

wire with ring terminal to connect grounding.

6. PV Module (DC) Connection

CAUTION: Before connecting to PV modules, please install **separately** a DC circuit breaker between inverter and PV modules.

NOTE 1: Please use 1000VDC/80A circuit breaker.

NOTE 2: The overvoltage category of the PV input is II.

Please follow below steps to implement PV module connection:

CAUTION: It's requested to have PV junction box with surge protection. Otherwise, it will cause inverter damage when lightning occurs on PV modules.

Step 1: Check the input voltage of PV array modules. The acceptable input voltage of the inverter is 450VDC - 950VDC. Please make sure that the maximum current load of PV input connector is 72A.

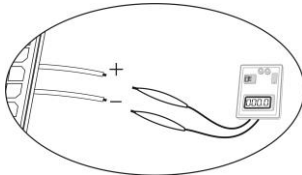

CAUTION: Exceeding the maximum input voltage can destroy the unit!! Check the system before wire connection.

Step 2: Remove insulation sleeve 12 mm and insert conductor into cable ring terminal.

WARNING! It's very important for system safety and efficient operation to use appropriate cable for PV module connection. To reduce risk of injury, please use the proper recommended cable size as below.

Ring terminal:

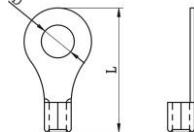

Wire Size	Ring Terminal			Torque value
	Cable mm ²	Dimensions		
		D (mm)	L (mm)	
6 AWG	14	8.4	32	12.0 Nm

Step 3: Check correct polarity of connection cable from PV modules and PV input connectors. Then, connect positive pole (+) of connection cable to positive pole (+) of

PV input connector. Connect negative pole (-) of connection cable to negative pole (-) of PV input connector.

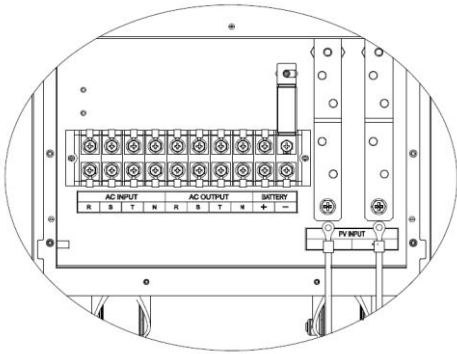

CAUTION: Never directly touch terminals of the inverter. It will cause lethal electric shock.

CAUTION: Do NOT touch the inverter to avoid electric shock. When PV modules are exposed to sunlight, it may generate DC voltage to the inverter.

Recommended Panel Configuration

Solar Panel Spec. (reference)	# PV modules	Q'ty of panels	Total Input Power
	(Min in serial: 12pcs; Max. in serial: 21pcs)		
- 300Wp - Vmp: 36.7Vdc - Imp: 6.818A - Voc: 44Vdc - Isc: 7.636A - Cells: 72	21pcs in serial	21pcs	6300W
	21 pcs in serial, 5 strings in parallel	105pcs	31500W
	21 pcs in serial, 7 strings in parallel	147pcs	44100W
	19 pcs in serial, 8 strings in parallel	152pcs	45600W

7. Battery Connection

CAUTION: Before connecting to batteries, please install **separately** a DC circuit breaker between inverter and batteries.

NOTE 1: Please only use sealed lead acid battery, vented and Gel battery. Please check maximum charging voltage and current when first using this inverter. If using Lithium iron or Nicd battery, please consult with installer for the details.

NOTE 2: Please use 500VDC/100A circuit breaker.

NOTE 3: The overvoltage category of the battery input is II.
Please follow below steps to implement battery connection:

Step 1: Check the nominal voltage of batteries. The nominal input voltage for inverter is 384VDC.

Step 2: Use two battery cables. Remove insulation sleeve 12 mm and insert conductor into cable ring terminal. Refer to right chart.

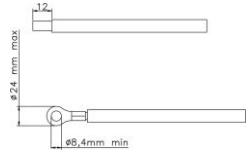

WARNING! It's very important for system safety and efficient operation to use appropriate cable for battery connection. To reduce risk of injury, please use the proper recommended cable size as below.

Nominal Battery Voltage	384V
Conductor cross-section (mm ²)	22
AWG no.	4

Step 3: Remove battery cover and follow battery polarity guide printed near the battery terminal! Place the external battery cable ring terminal over the battery terminal.

RED cable to the positive terminal (+);
BLACK cable to the negative terminal (-).

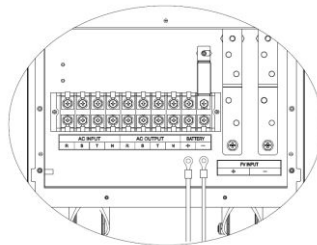

WARNING! Wrong connections will damage the unit permanently.

Step 4: Make sure the wires are securely connected. The reference tightening torque is 12.0 N.m.

8. Load (AC Output) Connection

CAUTION: To prevent further supply to the load via the inverter during any mode of operation, an additional disconnection device should be placed on in the building wiring installation.

WARNING! It's very important for system safety and efficient operation to use appropriate cable for AC connection. To reduce risk of injury, please use the proper recommended cable size as below.

Model	30KW
Nominal Grid Voltage	230VAC
Conductor cross-section (mm ²)	8
AWG no.	8

Please follow below steps to implement AC input connection:

1. Before making AC input/output connection, be sure to open DC protector or disconnecter first.
2. Remove insulation sleeve 12 mm and insert conductor into cable ring terminal. Refer to right chart.

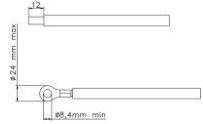

Recommended wire and terminal size:

Wire Size	Ring Terminal			Torque value
	Cable mm ²	Dimensions		
		D (mm)	L (mm)	
8 AWG	8	8.4	29	12.0 Nm

Ring terminal:

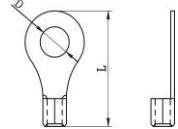

3. Insert AC input wires according to polarities indicated on terminal block and tighten the terminal screws. Be sure to connect PE protective conductor (⊕) first.

⊕ → **Ground (yellow-green)**

R Phase → **LINE (black)**

Y Phase → **LINE (gray)**

B Phase → **LINE (brown)**

N → **Neutral (blue)**

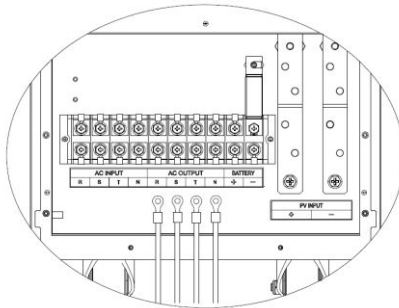

CAUTION: It's only allowed to connect load to "AC Output Connector". Do NOT connect the utility to "AC Output Connector".

CAUTION: Be sure to connect L terminal of load to L terminal of "AC Output Connector" and N terminal of load to N terminal of "AC Output Connector". The G terminal of "AC Output Connector" is connected to grounding of the load. Do NOT mis-connect.

9. Communication

9.1. Serial Communication & Intelligent Slot

The inverter is equipped with several communication ports and it is also equipped with a slot for alternative communication interfaces in order to communicate with a PC with corresponding software. This intelligent slot is suitable to install with SNMP card and Modbus card. Follow below procedure to connect communication cable and install the software.

For RS232 port, you should use a DB9 cable as the following:

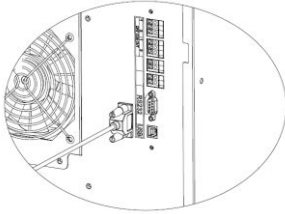

For USB port, you should use a USB cable as the following:

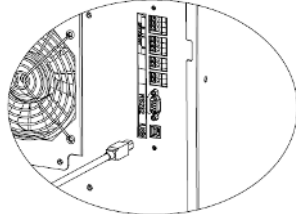

For SNMP or MODBUS card, you should use RJ45 cables as the following:

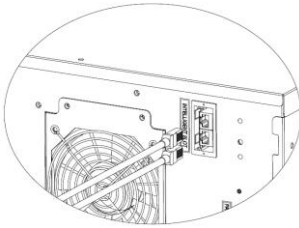

Please install monitoring software in your computer. Detailed information is listed in the next chapter. After software is installed, you may initial the monitoring software and extract data through communication port.

9.2. Dry Contact

There is one dry contact available on the bottom panel. It could be used to remote control for external generator.

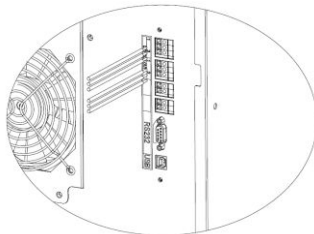

9.2.1. Electric Parameter

Parameter	Symbol	Max.	Unit
Relay DC voltage	Vdc	30	V
Relay DC current	Idc	1	A

Note: The application of the dry contact should not exceed the electric parameter shown as above. Otherwise, the internal relay will be damaged.

10. Commissioning

Step 1: Check the following requirements before commissioning:

- Ensure the inverter is firmly secured
- Check if the open circuit DC voltage of PV module meets requirement (Refer to Section 6)
- Check if the open circuit utility voltage of the utility is at approximately same to the nominal expected value from local utility company.
- Check if connection of AC cable to grid (utility) is correct if the utility is required.
- Full connection to PV modules.
- AC circuit breaker (only applied when the utility is required), battery circuit breaker, and DC circuit breaker are installed correctly.

Step 2: Switch on the battery circuit breaker and then switch on DC breaker on PV terminals. After that, if there is utility connection, please switch on the AC circuit breaker. At this moment, the inverter is turned on already. However, there is no output generation for loads. Then:

- If LCD lights up to display the current inverter status, commissioning has been successfully. After pressing "ON" button for 1 second when the utility is detected, this inverter will start to supply power to the loads. If no utility exists, simply press "ON" button for 3 seconds. Then, this inverter will start to supply power to the loads.
- If a warning/fault indicator appears in LCD, an error has occurred to this inverter. Please inform your installer.

Step 3: Please insert CD into your computer and install monitoring software in your PC. Follow below steps to install software.

1. Follow the on-screen instructions to install the software.
2. When your computer restarts, the monitoring software will appear as shortcut icon located in the system tray, near the clock.

NOTE: If using modbus card as communication interface, please install bundled software. Check local dealer for the details.

11. Initial Setup

Before inverter operation, it's required to set up "Operation Mode" via software. Please strictly follow below steps to set up. For more details, please check software manual.

Step 1: After turning on the inverter and installing the software, please click "Open Monitor" to enter main screen of this software.

Step 2: Log in into software first by entering default password "administrator".

Step 3: Select Device Control>>MyPower Management. It is to set up inverter operation mode and personalized interface. Refer to diagram below.

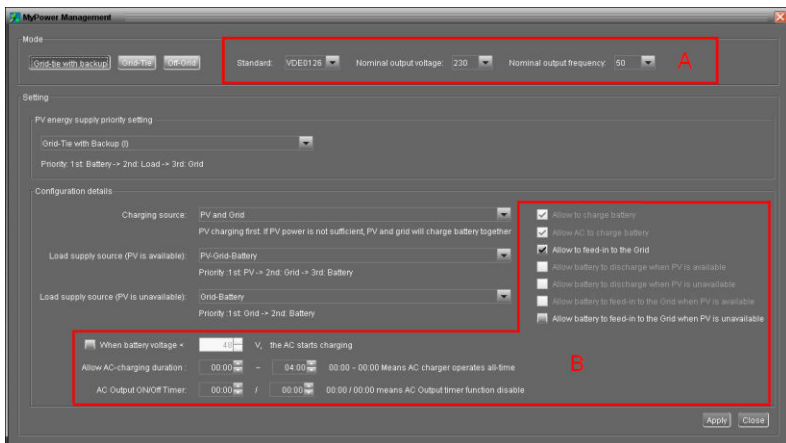
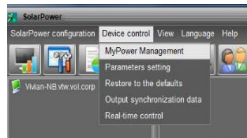

Mode

There are three operation modes: Grid-tie with backup, Grid-Tie and Off-Grid.

- Grid-tie with backup: PV power can feed-in back to grid, provide power to the load and charge battery. There are three options available in this mode: Grid-tie with backup I, II and III. In this mode, users can configure PV power supply priority, charging source priority and load supply source priority.
- Grid-Tie: PV power only can feed-in back to grid.
- Off-Grid: PV power only provides power to the load and charge battery. No feed-in back to grid is allowed.

SECTION A:

Standard: It will list local grid standard. It's requested to have factory password to make any modifications. Please check local dealer only when this standard change is requested.

CAUTION: Wrong setting could cause the unit damage or not working.

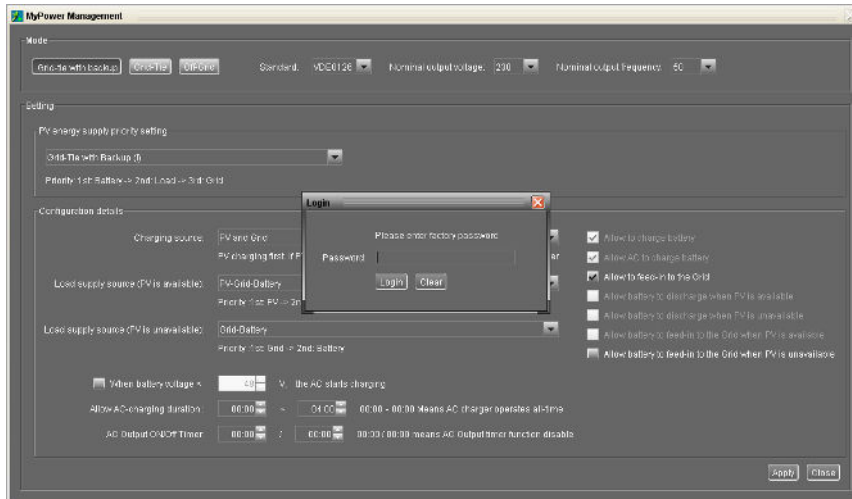

Nominal Output Voltage: 230V.

Nominal Output Frequency: 50HZ.

SECTION B:

This section contents may be different based on different selected types of operations.

Allow AC charging duration: It's a period time to allow AC (grid) to charge battery. When the duration is set up as 00:00-00:00, it means no time limitation for AC to charge battery.

AC output ON/Off Timer: Set up on/off time for AC output of inverter. If setting it as 00:00/00:00, this function is disabled.

Allow to charge battery: This option is automatically determined by setting in "Charging source". It's not allowed to modify here. When "NONE" is selected in charging source section, this option becomes unchecked as grey text.

Allow AC to charge battery: This option is automatically determined by setting in "Charging source". It's not allowed to modify here. When "Grid and PV" or "Grid or PV" is selected in charging source section, this option is default selected. Under

Grid-tie mode, this option is invalid.

Allow to feed-in to the Grid: This option is only valid under Grid-tie and Grid-tie with backup modes. Users can decide if this inverter can feed-in to the grid.

Allow battery to discharge when PV is available: This option is automatically determined by setting in "Load supply source (PV is available)". When "Battery" is higher priority than "Grid" in Load supply source (PV is available), this option is default selected. Under Grid-tie, this option is invalid.

Allow battery to discharge when PV is unavailable: This option is automatically determined by setting in "Load supply source (PV is unavailable)". When "Battery" is higher priority than "Grid" in Load supply source (PV is unavailable), this option is default selected. Under Grid-tie mode, this option is invalid.

Allow battery to feed-in to the Grid when PV is available: This option is only valid in Grid-tie with backup II or Grid-tie with backup III modes.

Allow battery to feed-in to the Grid when PV is unavailable: This option is only valid in all options of Grid-tie with backup mode.

Grid-tie with backup

● Grid-tie with backup (I) :

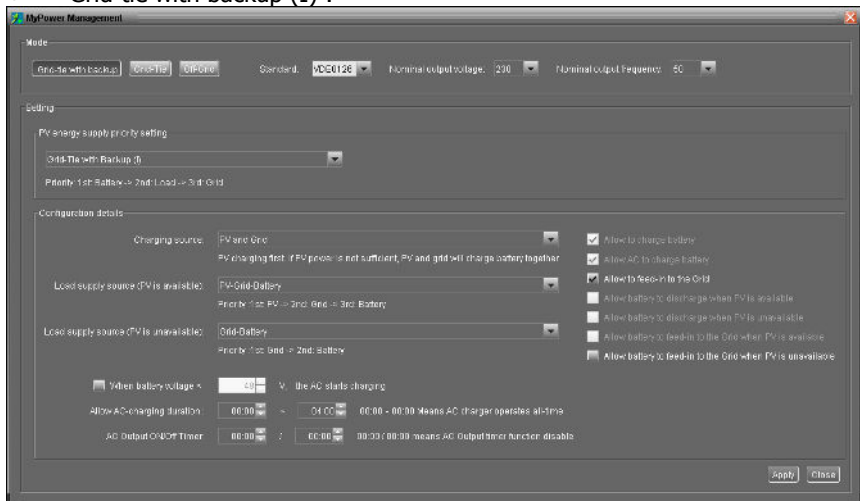

PV energy supply priority setting: 1st Battery, 2nd Load and 3rd Grid.

PV power will charge battery first, then provide power to the load. If there is any remaining power left, it will feed-in to the grid.

Battery charging source:

1. PV and Grid (Default)

It's allowed to charge battery from PV power first. If it's not sufficient, grid will charge battery.

2. PV only

It is only allow PV power to charge battery.

3. None

It is not allowed to charge battery no matter it's from PV power or grid.

Load supply source:

When PV power is available: 1st PV, 2nd Grid, 3rd Battery

If battery is not fully charged, PV power will charge battery first. And remaining PV power will provide power to the load. If it's not sufficient, grid will provide power to the load. If grid is not available at the same time, battery power will back up.

When PV power is not available:

1. 1st Grid, 2nd Battery (Default)

Grid will provide power to the load at first. If grid is not available, battery power will provide power backup.

2. 1st Battery, 2nd Grid

Battery power will provide power to the load at first. If battery power is running out, grid will back up the load.

NOTE: This option will become ineffective during AC charging time and the priority will automatically become 1st Grid and 2nd Battery order. Otherwise, it will cause battery damage.

● Grid-tie with backup (II) :

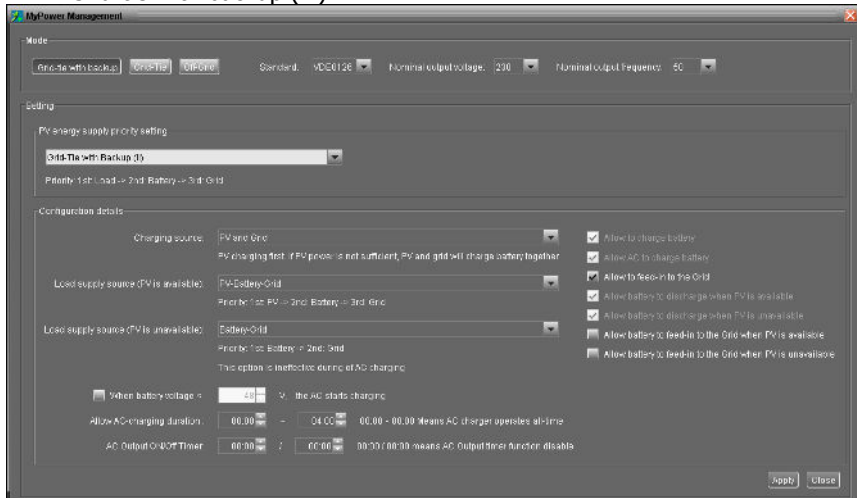

PV energy supply priority setting: 1st Load, 2nd Battery and 3rd Grid.

PV power will provide power to the load first. Then, it will charge battery. If there is any remaining power left, it will feed-in to the grid.

Battery charging source:

1. PV and Grid

It's allowed to charge battery from PV power first. If it's not sufficient, grid will charge battery.

2. PV only

It is only allow PV power to charge battery.

3. None

It is not allowed to charge battery no matter it's PV power or grid.

Load supply source:

When PV power is available:

1. 1st PV, 2nd Battery, 3rd Grid

PV power will provide power to the load first. If it's not sufficient, battery power will provide power to the load. When battery power is running out or not available, grid will back up the load.

2. 1st PV, 2nd Grid, 3rd Battery

PV power will provide power to the load first. If it's not sufficient, grid will provide power to the load. If grid is not available at the same time, battery power will back up.

When PV power is not available:

1. 1st Grid, 2nd Battery: Grid will provide power to the load at first. If grid is not available, battery power will provide power backup.
2. 1st Battery, 2nd Grid: Battery power will provide power to the load at first. If battery power is running out, grid will back up the load

NOTE: This option will become ineffective during AC charging time and the priority will automatically become 1st Grid and 2nd Battery order. Otherwise, it will cause battery damage.

● Grid-tie with backup (III):

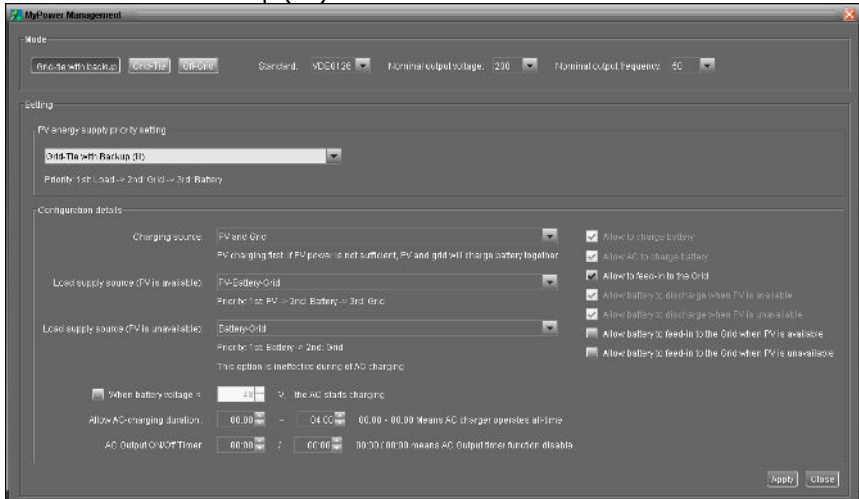

PV energy supply priority setting: 1st Load, 2nd Grid and 3rd Battery

PV power will provide power to the load first. If there is more PV power available, it will feed-in to the grid. If feed-in power reaches max. feed-in power setting, the remaining power will charge battery.

NOTE: The max. feed-in grid power setting is available in parameter setting. Please refer to software manual.

Battery charging source:

1. PV and Grid: It's allowed to charge battery from PV power first. If it's not sufficient, grid will charge battery.
2. PV only: It is only allow PV power to charge battery.
3. None: It is not allowed to charge battery no matter it's PV power or grid.

Load supply source:

When PV power is available:

1. 1st PV, 2nd Battery, 3rd Grid

PV power will provide power to the load first. If it's not sufficient, battery power will provide power to the load. When battery power is running out or not available, grid will back up the load.

2. 1st PV, 2nd Grid, 3rd Battery

PV power will provide power to the load first. If it's not sufficient, grid will provide power to the load. If grid is not available at the same time, battery power will back up.

When PV power is not available:

1. 1st Grid, 2nd Battery: Grid will provide power to the load at first. If grid is not available, battery power will provide power backup.

2. 1st Battery, 2nd Grid: Battery power will provide power to the load at first. If battery power is running out, grid will back up the load.

NOTE: This option will become ineffective during AC charging time and the priority will automatically become 1st Grid and 2nd Battery order. Otherwise, it will cause battery damage.

Grid-Tie

Under this operation mode, PV power only feeds-in to the grid. No priority setting is available.

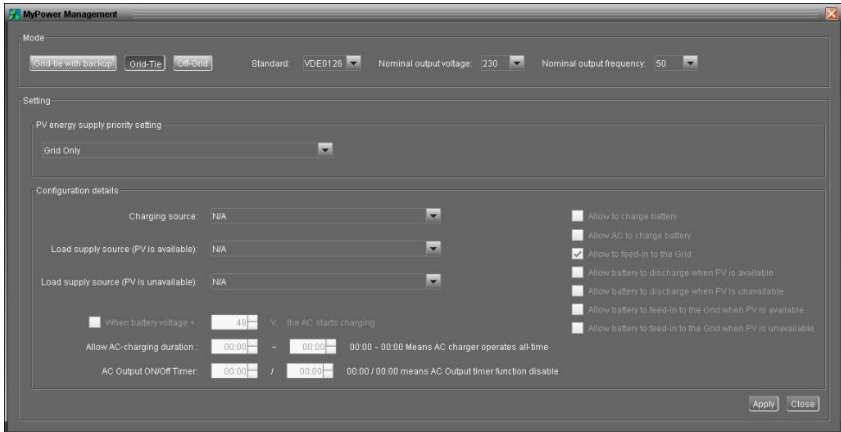

Off-Grid

- Off-Grid (I): Default setting for off-grid mode.

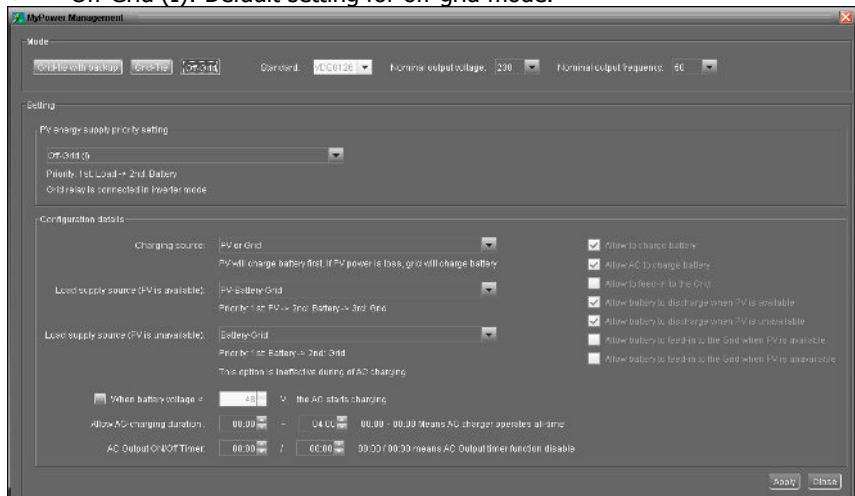

PV energy supply priority setting: 1st Load, 2nd Battery

PV power will provide power to the load first and then charge battery. Feed-in to

the grid is not allowed under this mode. At the same time, the grid relay is connected in Inverter mode. That means the transfer time from inverter mode to battery mode will be less than 10ms. Besides, it will avoid overload fault because grid can supply load when connected load is over 30KW.

Battery charging source:

1. PV or Grid: If there is remaining PV power after supporting the loads, it will charge battery first. Only until PV power is not available, grid will charge battery. (Default)
2. PV only: It is only allow PV power to charge battery.
3. None: It is not allowed to charge battery no matter it's PV power or grid.

Load supply source:

When PV power is available:

1. 1st PV, 2nd Battery, 3rd Grid (Default)

PV power will provide power to the load first. If it's not sufficient, battery power will provide power to the load. When battery power is running out or not available, grid will back up the load.

2. 1st PV, 2nd Grid, 3rd Battery

PV power will provide power to the load first. If it's not sufficient, grid will provide power to the load. If grid is not available at the same time, battery power will back up.

When PV power is not available:

1. 1st Grid, 2nd Battery

Grid will provide power to the load at first. If grid is not available, battery power will provide power backup.

2. 1st Battery, 2nd Grid (Default)

Battery power will provide power to the load at first. If battery power is running out, grid will back up the load.

NOTE: This option will become ineffective during AC charging time and the priority will automatically become 1st Grid and 2nd Battery order. Otherwise, it will cause battery damage.

Off-Grid (II)

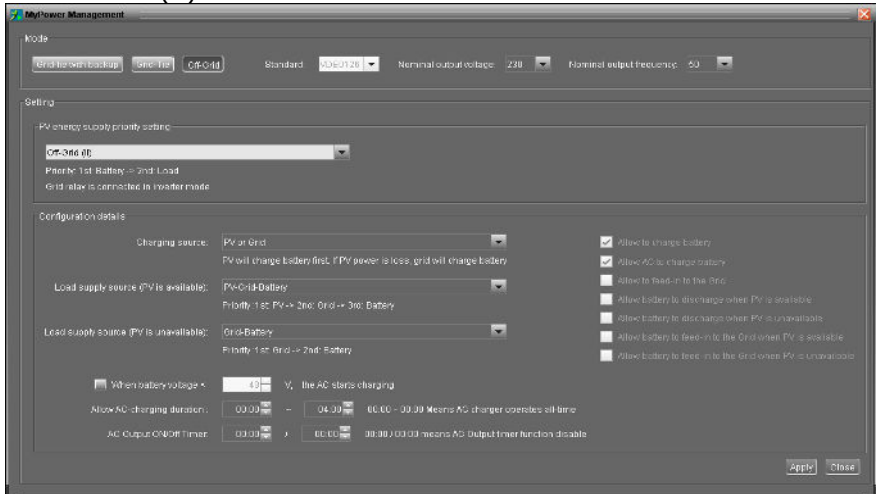

PV energy supply priority setting: 1st Battery, 2nd Load

PV power will charge battery first. After battery is fully charged, if there is remaining PV power left, it will provide power to the load. Feed-in to the grid is not allowed under this mode. At the same time, the grid relay is connected in Inverter mode. That means the transfer time from inverter mode to battery mode will be less than 10ms. Besides, it will avoid overload fault because grid can supply load when connected load is over 30KW.

Battery charging source:

1. PV or Grid: If there is remaining PV power after supporting the loads, it will charge battery first. Only until PV power is not available, grid will charge battery.
2. PV only: It is only allow PV power to charge battery.
3. None: It is not allowed to charge battery no matter it's PV power or grid.

NOTE: It's allowed to set up AC charging duration.

Load supply source:

When PV power is available: 1st PV, 2nd Grid, 3rd Battery

PV power will provide power to the load first. If it's not sufficient, grid will provide power to the load. If grid is not available at the same time, battery power will back up.

When PV power is not available:

1. 1st Grid, 2nd Battery: Grid will provide power to the load at first. If grid is not available, battery power will provide power backup.
2. 1st Battery, 2nd Grid: Battery power will provide power to the load at first. If battery power is running out, grid will back up the load.

NOTE: This option will become ineffective during AC charging time and the priority will automatically become 1st Grid and 2nd Battery order. Otherwise, it will cause battery damage.

Off-Grid (III)

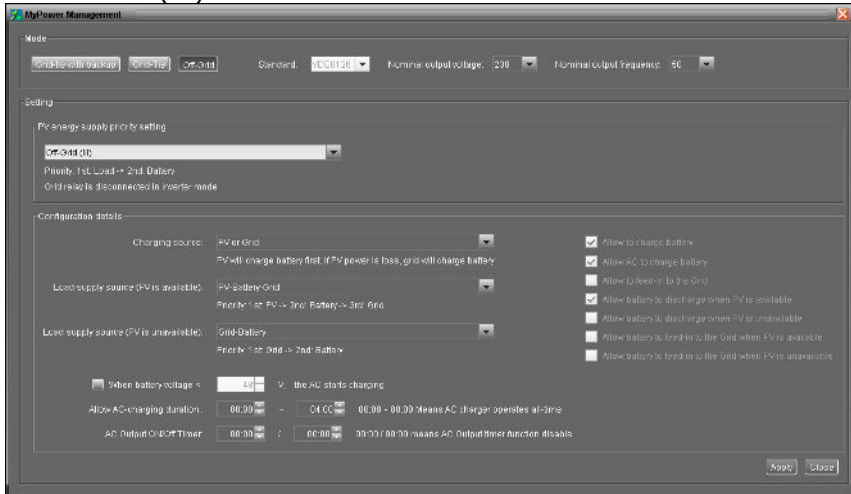

PV energy supply priority setting: 1st Load, 2ndBattery

PV power will provide power to load first and then charge battery. Feed-in to the grid is not allowed under this mode. The grid relay is NOT connected in Inverter mode. That means the transfer time from inverter mode to battery mode will be about 10ms. If connected load is over 30KW and grid is available, this inverter will allow grid to provide power to the loads and PV power to charge battery. Otherwise, this inverter will activate fault protection.

Battery charging source:

1. PV or Grid: If there is remaining PV power after supporting the loads, it will charge battery first. Only until PV power is not available, grid will charge battery.
2. PV only: It is only allow PV power to charge battery.
3. None: It is not allowed to charge battery no matter it's PV power or grid.

NOTE: It's allowed to set up AC charging duration.

Load supply source:

When PV power is available: 1st PV, 2nd Battery, 3rd Grid

PV power will provide power to the load first. If it's not sufficient, battery power will back up the load. Only after battery power is running, Grid will back up the load.

When PV power is not available:

1. 1st Grid, 2nd Battery: Grid will provide power to the load at first. If grid is not available, battery power will provide power backup.
2. 1st Battery, 2nd Grid: Battery power will provide power to the load at first. If battery power is running out, grid will back up the load.

NOTE: This option will become ineffective during AC charging time and the priority will automatically become 1st Grid and 2nd Battery order. Otherwise, it will cause battery damage.

12. Operation



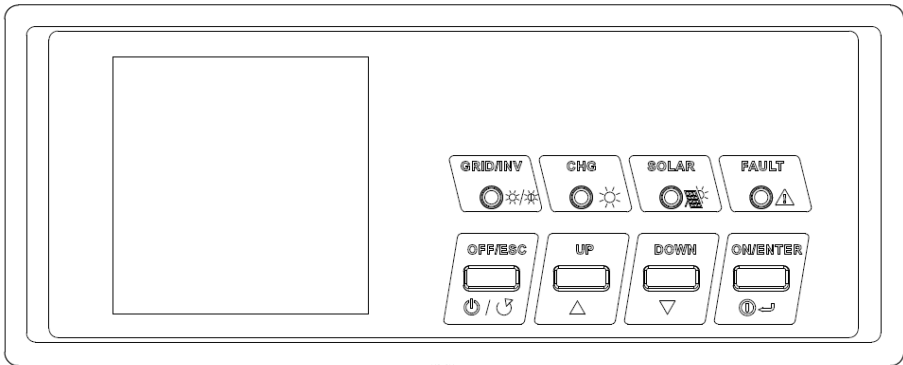

12.1 Control Panel



This display is operated by four buttons.

NOTICE: To accurately monitor and calculate the energy generation, please calibrate the timer of this unit via software every one month. For the detailed calibration, please check the user manual of bundled software.

12.1.1. LED indicators

LED Indicators	Messages	
	Solid On	Output is powered by utility in line mode.
	Flashing	Output is powered by battery or PV in battery mode.
	Solid On	Battery is fully charged.
	Flashing	Battery is charging.
	Solid On	PV is connected and can work normally.
	Flashing	PV is connected but the voltage is too low.
	Solid On	Fault occurs in the inverter.
	Flashing	Warning condition occurs in the inverter.

12.1.2. Buzzer

Inverter state	Buzzer status	Muted
Battery (normal battery voltage)	Beeping once every 4 seconds	Yes
Battery (low battery voltage)	Beeping once every second	Yes
Fault	Beeping continuously	Yes
Warnings (except overload)	Beeping once every second	No

12.1.3. Button definition

Button	Function Description
ON/ENTER	<ul style="list-style-type: none"> ➤ Enter setting menu: Press this button to enter setting menu. ➤ Enter Key: Press this button to confirm the selection in setting menu. ➤ Turn on output: Press and hold the button for 3 seconds to turn on the output.
OFF/ESC	<ul style="list-style-type: none"> ➤ Esc key: Press this button to exit from setting menu or cancel the setting. ➤ Turn off output: Press and hold the button for 3 seconds to turn off the output.
UP	<ul style="list-style-type: none"> ➤ Press this button to select the upper item in the menu or previous page in the screen or increase the number in the setting.
DOWN	<ul style="list-style-type: none"> ➤ Press this button to select the lower item in the menu or next page in the screen or decrease the number in the setting.

NOTE: If backlight shuts off, you may activate it by pressing any button. When an error occurs, the buzzer will continuously sound. You may press "OFF/ESC" button to mute it.

12.2. LCD Information

12.2.1. Basic

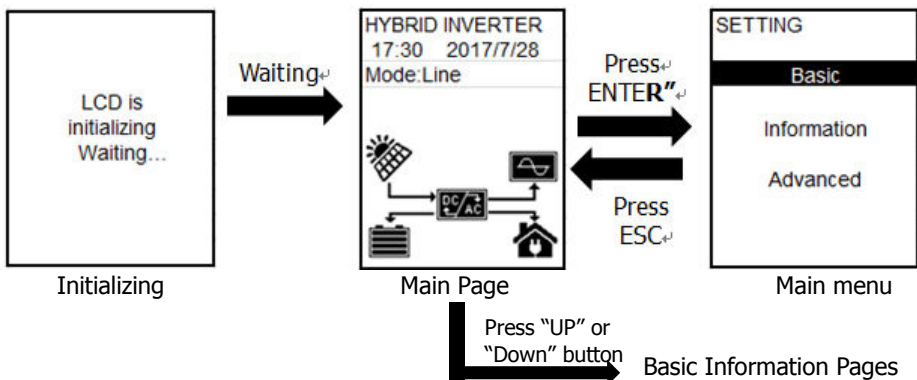

After the inverter is powered on, LCD will initialize first and then display main page. After pressing "ENTER" button, it will enter main menu.

➤ Initialization

When first starting up the inverter, the LCD will show initialization. Please kindly wait.

➤ Main page

This page is used to display dynamic flow chart of the inverter (refer to screen chart in previous page). In main page, users can get the inverter basic information by pressing "UP" or "DOWN" button. In basic information pages, press "ESC" button to return to main page.

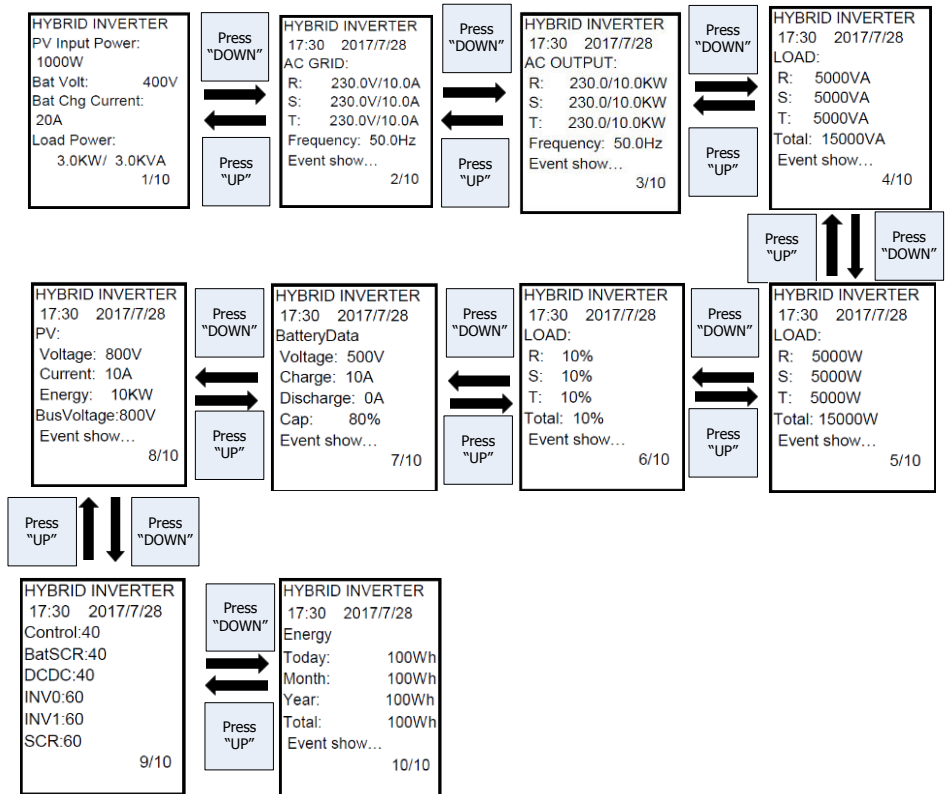

➤ Basic Information Pages

Page number	Parameters description
PAGE1	PV input power, battery voltage and charge current, load power
PAGE2	Grid input voltage, frequency and current in 3 phases
PAGE3	Output voltage, frequency and active power in 3 phases
PAGE4	Output apparent power in 3 phases and total power
PAGE5	Output active power in 3 phases and total power
PAGE6	Load percentages in 3 phases and total load percentage
PAGE7	Battery voltage, charge/discharge current and capacity
PAGE8	PV voltage ,current and power and DC bus voltage
PAGE9	Internal temperature of the inverter
PAGE10	Energy data generated in daily, monthly and total
Event show	Warning code

➤ Main menu

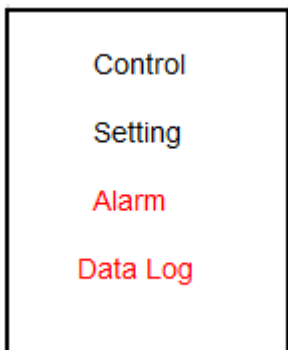

Control: Main function setting.

Setting: Parameter settings of the Inverter.

Alarm: Shows current warning or fault information

Data log: Records the events of the inverter

- 1) Press "UP" or "DOWN" button to select sub-menus. When selected, the text will be highlighted.
- 2) Press "ON/ENTER" button to confirm the selection.
- 3) Press "OFF/ESC" button to return to main page.

12.3. Sub-menus

12.3.1. Control sub-menu

Press "ON/ENTER" button to confirm the selection. Then, press "OFF/ESC" button to return to main menu (refer to 12-2-1).

Turn On: "Turn On" will be displayed if the inverter is not turned on. Otherwise, "Turn off" will be displayed.

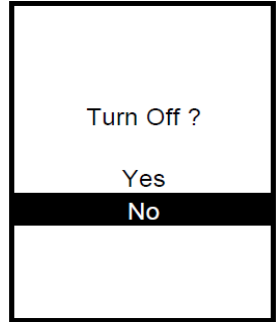
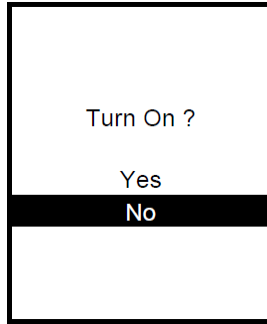
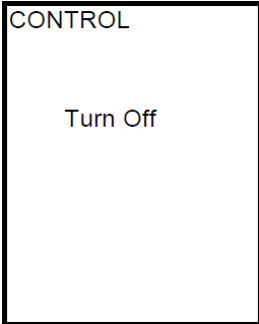

12.3.2. Setting Sub-menus

This sub-menu is used to set the parameters of the inverter and show the parameter setting information. There are 3 options: Basic, Information and Advanced. Press "UP" or "DOWN" button to switch selection. Press "ON/ENTER" button to confirm the selection. Then, press "OFF/ESC" button to return to main menu (refer to 12-2-1).

NOTE: Not all settings could be available in every operation mode. If the setting is not available in present mode, the LCD will keep its original setting parameter showed instead of changing the parameters.

LCD Screen	Parameters	Description
SETTING	Basic	It's to set up basic information of the Inverter. It's not relative to any function parameter.
Basic	Information	The information of the inverter default information.
Information	Advanced	It's required to enter password to access the "ADVANCED" setting.
Advanced		

➤ Basic Setting

LCD Screen	Description
BASIC SETTING Clock:15:25 Date :2017/09/06 Day:Sunday Language:English 1/1	<ol style="list-style-type: none"> 1. Clock: Set the time. The time format is HH:MM:SS. 2. Date: Set the date. The date format is YYYY /MM/DD. 3. Day: Set the calendar day. 4. Language: Set the LCD language. There are two options: English and Chinese. English is default setting.

➤ **Information**

LCD Screen	Description
	<ol style="list-style-type: none"> 1. MCU: MCU version. 2. DSP: DSP version. 3. HW: Hardware version. 4. Serial Number: The serial number of the inverter.

➤ **Advanced**

There are two sub-menus under “Advanced”, Setting and Service. Both of they are required to enter password (4 digits).

Setting

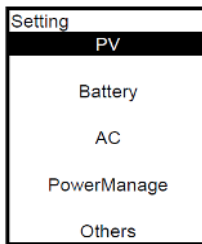
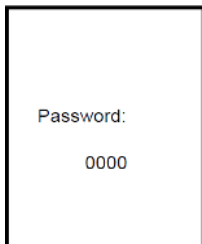

It's required to enter password (4 digits) to access the “Setting”. The default password is “0000”. If entered password is right, the page will jump to setting screen. If the password is wrong, it will ask to enter again.

This sub-menu is used to set the Users parameters of the inverter and show the parameter setting information. There are 5 options: PV, Battery, AC, Power Manage and Others. Press “UP” or “DOWN” button to switch different selections. Press “ON/ENTER” button to confirm the selection.

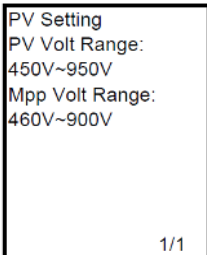
PV Setting	
LCD Screen	Description
	<ol style="list-style-type: none"> 1. PV Volt Range: Select the PV working voltage range. The setting range for low voltage point is 450V~600V and high voltage point is 800V~950V. 2. Mpp Volt Range: Select the PV MPP voltage range. The setting range for low voltage point is 460V~600V and for high voltage point is 700V~900V.

Battery Setting	
LCD Screen	Description
<p>Battery Setting Charge Current MAX:40A Float Voltage: 432V CV Voltage: 448V</p> <p style="text-align: right;">1/3</p>	<p>1. Charge Current: Select the maximum battery charging current. The setting range is 1A~80A.</p> <p>2. Float Voltage: Select the battery floating charging voltage. The setting range is 384V~480V.</p> <p>3. CV Voltage: Select the maximum battery bulk charging voltage. The setting range is 384V~480V.</p>
<p>Battery Setting Grid available Max Bat discharge: 150A Grid available Bat Dischg Off: 384V Bat Re-dischg: 432V</p> <p style="text-align: right;">2/3</p>	<p>1. Max Bat discharge: Select the maximum battery discharge current when grid is available. The setting range is 10A~150A.</p> <p>2. Bat Discharge Off: Select the battery discharge cut-off voltage when grid is available. The setting range is 336V~480V.</p> <p>3. Bar Re-discharge: Select the battery re-discharge voltage when grid is available. The setting range is 336V~480V.</p>
<p>Battery Setting Grid unavailable Bat Dischg Off:: 336V Bat Re-dischg: 384V</p> <p style="text-align: right;">3/3</p>	<p>1. Bat Discharge Off: Select the battery discharge cut-off voltage when grid is unavailable. The setting range is 320V~480V.</p> <p>2. Bar Re-discharge: Select the battery re-discharge voltage when grid is unavailable. The setting range is 320V~480V.</p>

AC Setting

LCD Screen

Description

AC Setting
Grid Volt Range
:184V~264V
Grid Freq.Range
:47.4Hz~51.5Hz
Feed Grid Power
:30KW

1/3

1. Grid Volt Range: Setting the feed-in grid voltage range.

The setting range for Off-grid mode.

OP rated voltage(V)	Min. Grid Connected Voltage (V)	Max. Grid Connected Voltage (V)
200	170~190	210~280
202	170~192	212~280
208	170~198	218~280
220	170~210	230~280
230	170~220	240~280

The setting range for Hybrid mode.

OP rated voltage(V)	Min. Grid Connected Voltage (V)	Max. Grid Connected Voltage (V)
200	180~195	205~276
202	180~199	207~276
208	180~203	213~276
220	180~115	225~276
230	180~225	235~276

2. LineFreq Range: Setting the feed-in grid frequency range.

The setting range for Off-grid mode.

OP rated frequency (HZ)	Min. Grid Connected frequency (HZ)	Max. Grid Connected frequency (HZ)
50	45~49.5	50.5~55
60	55~59.5	60.5~65

The setting range for Hybrid mode.

OP rated frequency (HZ)	Min. Grid Connected frequency (HZ)	Max. Grid Connected frequency (HZ)
50	45~49.9	50.1~55
60	55~59.9	60.1~65

3. Feed Grid Power: Select the maximum feeding Power.

The setting range is 1KW~30KW.

<p>AC Setting Generator Source :En Wide AC Input: :En AC Charge Time :12:00~12: 00 AC Output Time :12:00~12: 00 2/3</p>	<p>1. Generator Source: Enable or disable to connect to the generator as power source.</p> <p>2. Wide AC Input: Dis: If disabled, the acceptable AC input voltage range will be determined by setting voltage between min. grid-connected voltage and max. grid-connected voltage and setting frequency between min. grid-connected frequency and max. grid-connected frequency. En: If enabled, AC input voltage range will become 170V ~ 280V. The acceptable frequency range become 40Hz ~ 55Hz for 50 Hz system and 55Hz ~ 65Hz for 60 Hz system. When either AC input voltage or AC input frequency is beyond the grid-connected setting range, it's not allowed to feed back to the grid. At this time, it's only available to provide power to loads or charge battery.</p> <p>3. AC Charge Time: The duration to allow grid to charge battery. If "00:00~00:00" is set up, it means always charging.</p> <p>4. AC Output Time: The duration to allow the AC output turn-on. If "00:00~00:00" is set up, it means AC output always turn on.</p>
<p>AC Setting Inverter Voltage: 230V Inverter Freq: 50Hz Grid-Connect Wait Time:5s 3/3</p>	<p>1. Inverter Voltage: Select the output rated voltage. There are five options, 200Vac, 202Vac, 208Vac, 220Vac and 230Vac. 230Vac is default setting.</p> <p>2. Inverter Freq: Select the output frequency 50Hz: The output frequency is setting for 50Hz. 60Hz: The output frequency is setting for 60Hz. 50Hz is default setting.</p> <p>3. Grid-Connect wait time: Set up the waiting time to feed-in to the grid.</p>

Power Manage	
LCD Screen	Description
<div style="border: 1px solid black; padding: 5px;"> Power Manage Standard: VDE0126 Mode:Hybrid-II Chg Source :PV And Grid Load Source I:Pv-Grid-Bat II:Grid-Bat <div style="text-align: right;">1/2</div> </div>	<p>1. Standard: Select the regulations for feed-in grid voltage/frequency.</p> <p>2. Mode: Select operation mode. There are 8 options, grid-tie with backup (hybrid I, II, III and IV), grid-tie and off-grid (I, II and III).</p> <p>3. Chg Source: Select the battery charging source.</p> <p>4. Load Source: Select the load supply source. Different operation mode will be different load supply sources. Please refer to "Initial Setup" SECTION B.</p>
<div style="border: 1px solid black; padding: 5px;"> Power Manage Allow Feed Grid: En PV Loss Allow Bat Feed Grid:En PV OK Allow Bat Feed Grid:En <div style="text-align: right;">2/2</div> </div>	<p>1. Allow Feed Grid: Enable/disable feed-in grid.</p> <p>2. PV Loss Allow Bat Feed Grid: Enable/disable battery feed-in to the grid when PV is unavailable.</p> <p>3. PV OK Allow Bat Feed Grid: Select enable/disable feed-in to the grid when PV is available.</p> <p>NOTE: Battery feeding grid function is invalid when the inverter allows grid to charge battery.</p>
Others	
LCD Screen	Description
<div style="border: 1px solid black; padding: 5px;"> Others Buzzer Alarm:Dis Standby Mode Buzzer Alarm:Dis Battery Mode Buzzer Alarm:Dis Parallel:Parallel <div style="text-align: right;">1/1</div> </div>	<p>1. Buzzer Alarm: Enable or disable buzzer alarm.</p> <p>2. Standby Mode Buzzer Alarm: Enable or disable buzzer alarm when inverter is working in standby mode.</p> <p>3. Battery Mode Buzzer Alarm: Enable or disable buzzer alarm when inverter is working in battery mode.</p> <p>4. Parallel: Single or parallel operation. If "parallel" is selected, LCD main page will show master or slave. Below chart is the screen shot in main screen.</p>
	<div style="border: 1px solid black; padding: 5px; text-align: center;"> HYBRID INVERTER 17:30 2017/7/28 Mode:Line ParaMode:Master  </div>

Calibration	
LCD Screen	Description
<p>CALIBRATION Input Voltage: R =220.2V ->2048 S =220.2V ->2048 T =220.2V ->2048</p> <p style="text-align: right;"><i>1/7</i></p>	<p>Input voltage: Calibrate input R/S/T voltage setting</p>
<p>CALIBRATION Output Voltage: R =220.2V ->2048 S =220.2V ->2048 T =220.2V ->2048 Output Current: R = 25.2A ->2048 S = 25.2A ->2048 T = 25.2A ->2048</p> <p style="text-align: right;"><i>2/7</i></p>	<ol style="list-style-type: none"> 1. Output voltage: Calibrate output R/S/T voltage setting 2. Output Current: Calibrate output R/S/T current setting
<p>CALIBRATION INV Voltage: R =220.2V ->2048 S =220.2V ->2048 T =220.2V ->2048 INV Current: R = 25.2A ->2048 S = 25.2A ->2048 T = 25.2A ->2048</p> <p style="text-align: right;"><i>3/7</i></p>	<ol style="list-style-type: none"> 1. INV voltage: Calibrate INV R/S/T voltage setting 2. INV Current: Calibrate INV R/S/T current setting

<p>CALIBRATION DC Bus Voltage: 423.1V ->2048 Battery Voltage: 303.0V-> 2048 PV Voltage: 303.0V-> 2048</p> <p style="text-align: right;">4/7</p>	<ol style="list-style-type: none"> DC Bus Voltage: Calibrate DC Bus voltage setting. Battery Voltage: Calibrate battery voltage setting. PV Voltage: Calibrate PV voltage setting.
<p>CALIBRATION Out. Vol. Offset: R= 0.0V->0 S= 0.0V->0 T= 0.0V->0 Out. Cur. Offset: R= 0.0A->0 S= 0.0A->0 T= 0.0A->0</p> <p style="text-align: right;">5/7</p>	<ol style="list-style-type: none"> Out. Vol. Offset: Calibrate output voltage offset setting. Out. Cur.Offset: Calibrate output Current offset setting.
<p>CALIBRATION Charging Current: 5.3A ->2048 Charg.C .Offset: 0.0A ->0</p> <p style="text-align: right;">6/7</p>	<ol style="list-style-type: none"> Charging Current: Calibrate charging current setting by percentage. Charge. C. Offset: Calibrate charging current offset setting by Ampere.
<p>CALIBRATION Inv. Vol. Offset: R= 0.0V->0 S= 0.0V->0 T= 0.0V->0 Inv. Cur. Offset: R= 0.0A->0 S= 0.0A->0 T= 0.0A->0</p> <p style="text-align: right;">7/7</p>	<ol style="list-style-type: none"> Inv. Vol. Offset: Calibrate Inv voltage offset setting. Inv. C. Offset: Calibrate charging current offset setting by Ampere.

Initialize		
<p>INITIALIZE</p> <p>Data Log</p> <p>Parameter</p> <p>Calibration Factor</p> <p>EEPROM</p> <p>Initialize menu</p>	<p>INITIALIZE</p> <p>Do you want to initialize the Data Log Factor?</p> <p>YES</p> <p>NO</p>	<p>INITIALIZE</p> <p>Do you want to initialize the Data Log Factor?</p> <p>YES</p> <p>NO</p>
	<p>INITIALIZE</p> <p>Do you want to initialize the Parameters?</p> <p>YES</p> <p>NO</p>	<p>INITIALIZE</p> <p>Do you want to initialize the Parameters?</p> <p>YES</p> <p>NO</p>
	<p>INITIALIZE</p> <p>Do you want to initialize the Calibration?</p> <p>YES</p> <p>NO</p>	<p>INITIALIZE</p> <p>Do you want to initialize the Calibration?</p> <p>YES</p> <p>NO</p>
	<p>INITIALIZE</p> <p>Do you want to initialize the EEPROM?</p> <p>YES</p> <p>NO</p>	<p>INITIALIZE</p> <p>Do you want to initialize the EEPROM?</p> <p>YES</p> <p>NO</p>

12.3.3. Alarm sub-menu

ALARM page is used to display the current warning and fault information of the inverter. If no alarm occurs, it's blank. Please refer to section 15-1 for the warning code. Please refer to section 15-2 for the fault code. Press "ESC" button to go back to main menu.

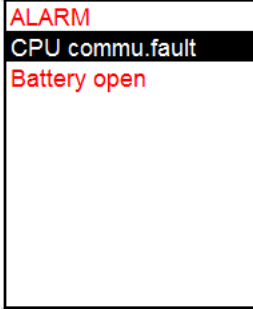
LCD Screen	Description
 <p>ALARM CPU commu.fault Battery open</p>	

12.3.4 Data log sub-menu

“Data log” is used to record the warning and fault information of the inverter. The record contains code, basic information and time.

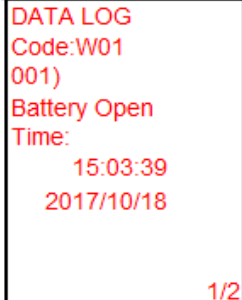
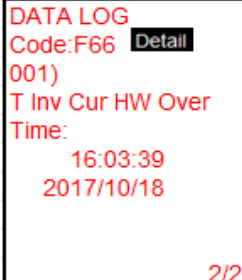
LCD Screen	Description
 <p>DATA LOG Code:W01 (001) Battery Open Time: 15:03:39 2017/10/18 1/2</p>	<p>Press “UP” and “DOWN” to page up or down if the log has more than one page. Press “ESC” button to go back main menu. Press “ENTER” button to access the detail page.</p> <ul style="list-style-type: none"> ● W + number: Warning + Warning code ● F + number: Fault + Fault code Detail <p>Please refer to part 15.1 and 15.2 for detailed list about warning and fault.</p>
 <p>DATA LOG Code:F66 Detail (001) T Inv Cur HW Over Time: 16:03:39 2017/10/18 2/2</p>	<p>Detail: It shows input and output information while fault occurs. Simply click “Detail” button, it will pop up the details. Below are the pop up screens.</p>

FAULT DETAIL Line Voltage: 228V 229V 228V Inverter Voltage: 0V 0V 0V Output Voltage: 0V 0V 0V IP Freq:50.0Hz OP Freq:50.0Hz 1/5	FAULT DETAIL Output Current: 0A 0A 0A Inverter Current: 0A 0A 0A Load Percent: 0% 0% 0% 2/5	FAULT DETAIL Battery:400V Battery:10A Bus Voltage:400V PV Volt:500V PV Power:500W 3/5
FAULT DETAIL Over Temperature BAT : 0 DCDC: 0 SCR : 0 INV1: 0 INV2: 0 Bits Of Status Worn: 0040 System: 011F 4/5	FAULT DETAIL Mode Before: Standby 5/5	

12.4. Operation Mode & Display

Inverter mode with grid connected

This inverter is connected to grid and working with DC/INV operation.

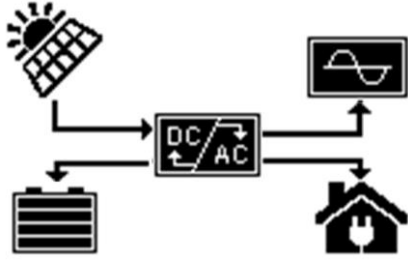
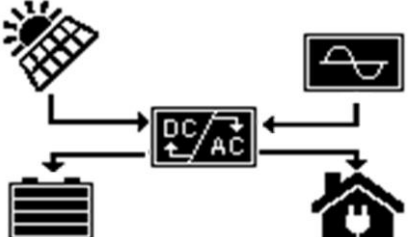
LCD Display	Description
	PV power is sufficient to charge battery, provide power to loads, and then feed in to the grid.
	PV power and utility is sufficient to charge the battery and supplying power to the connected load.

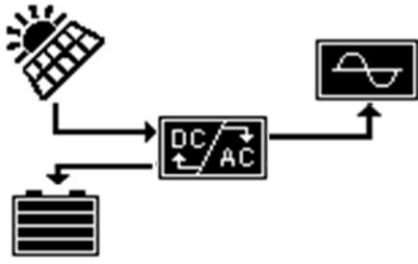
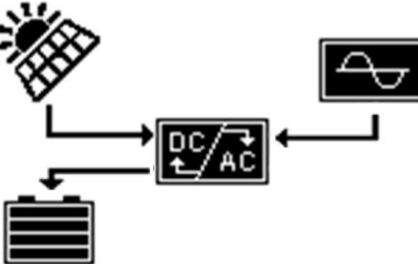
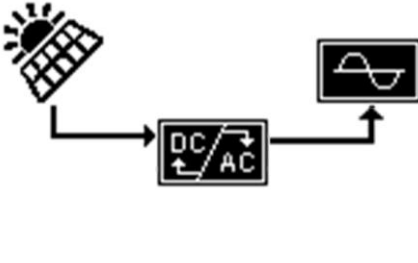
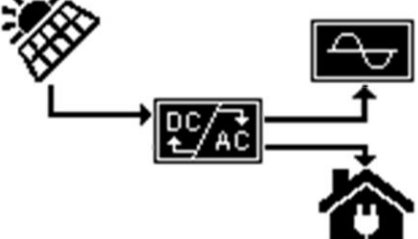
 <p>The diagram shows a solar panel (PV) and a battery connected to a central DC/AC inverter. Arrows indicate power flow from both the PV and the battery into the inverter. From the inverter, an arrow points to an AC output symbol (a sine wave).</p>	<p>This inverter is disabled to generate power to the loads via AC output. PV power is sufficient to charge battery first. Remaining PV power will feed in back to grid.</p>
 <p>The diagram shows a solar panel (PV) and a utility power source (represented by a sine wave) connected to a central DC/AC inverter. Arrows indicate power flow from both the PV and the utility into the inverter. From the inverter, an arrow points to a battery, indicating it is being charged.</p>	<p>This inverter is disabled to generate power to the loads via AC output. PV power and utility are charging battery at the same time because of insufficient PV power.</p>
 <p>The diagram shows a solar panel (PV) connected to a central DC/AC inverter. An arrow points from the PV into the inverter. From the inverter, an arrow points to an AC output symbol (a sine wave), representing power being fed back to the grid.</p>	<p>This inverter is disabled to generate power to the loads via AC output. PV power is feeding power back to the grid.</p>
 <p>The diagram shows a solar panel (PV) connected to a central DC/AC inverter. An arrow points from the PV into the inverter. From the inverter, two arrows point outwards: one to an AC output symbol (a sine wave) and another to a house icon with a plug, representing power being provided to loads.</p>	<p>PV power is sufficient to provide power to loads and feed power back to the grid.</p>

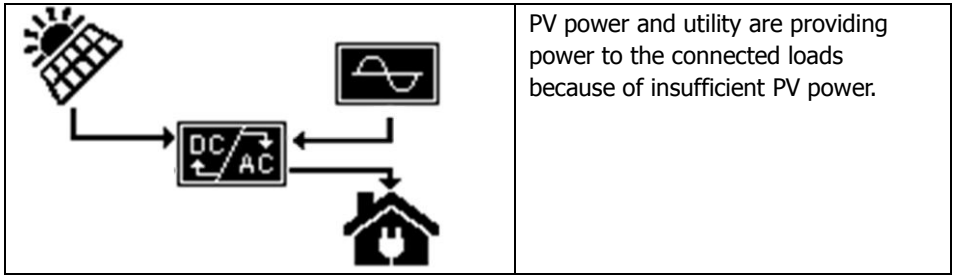

Inverter mode without grid connected

This inverter is working with DC/INV operation and not connecting to the grid.

LCD Display	Description
	<p>PV power is sufficient to charge battery and provide power to the connected loads.</p>
	<p>PV power is generated, but not sufficient to power loads by itself. PV power and battery are providing power to the connected loads at the same time.</p>
	<p>Only battery power is available to provide power to connected loads.</p>

Bypass mode

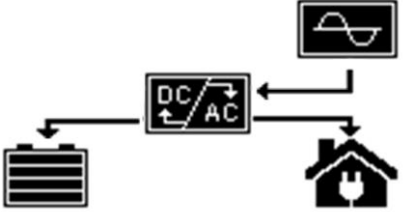
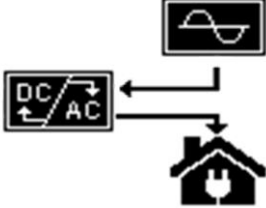

The inverter is working without DC/INV operation and connecting to the loads.

LCD Display	Description
	Only utility is charging battery and providing power to connected loads.
	Only utility is available to provide power to connected loads.

Standby mode:

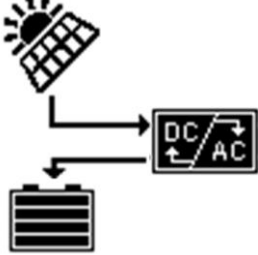
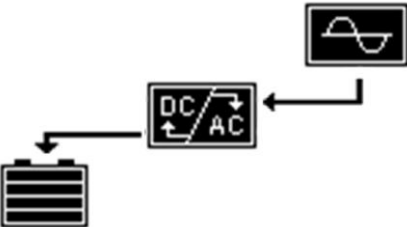
The inverter is working without DC/INV operation and load connected.

LCD Display	Description
	This inverter is disabled on AC output or even AC power output is enabled, but an error occurs on AC output. Only PV power is sufficient to charge battery.
	This inverter is disabled to generate power to the loads via AC output. PV power is not detected or available at this moment. Only utility is available to charge battery.

  	<p>If PV, battery or utility icons are flashing, it means they are not within acceptable working range. If they are not displayed, it means they are not detected.</p>
--	--

13. Charging Management

Charging Parameter	Default Value	Note
Charging current	10A	It can be adjusted via software from 1Amp to 80Amp.
Floating charging voltage (default)	432Vdc	It can be adjusted via software from 384Vdc to 480Vdc.
Max. absorption charging voltage (default)	448Vdc	It can be adjusted via software from 384Vdc to 480Vdc.
Battery overcharge protection	528Vdc	
Charging process based on default setting. 3 stages: First – max. charging voltage increases to 448V; Second- charging voltage will maintain at 448V until charging current is down to 8 Amp; Third- go to floating charging at 432V.		

This inverter can connect to battery types of sealed lead acid battery, vented battery, gel battery and lithium battery. The detail installation and maintenance explanations of the external battery pack are provided in the manufacturer's external battery pack of manual. If using sealed lead acid battery, please set up the max. charging current according to below formula:

$$\text{The maximum charging current} = \text{Battery capacity (Ah)} \times 0.2$$

For example, if you are using 300 Ah battery, then, maximum charging current is $300 \times 0.2 = 60$ (A). Please use at least 50Ah battery because the settable minimum value of charging current is 10A. If using AGM/Gel or other types of battery, please consult with installer for the details.

14. Maintenance & Cleaning

Check the following points to ensure proper operation of whole solar system at regular intervals.

- Ensure all connectors of this inverter are cleaned all the time.
- Before cleaning the solar panels, be sure to disconnect PV and Inverter.
- Clean the solar panels, during the cool time of the day, whenever it is visibly dirty.
- Periodically inspect the system to make sure that all wires and supports are securely fastened in place.

WARNING: There are no user-replaceable parts inside of the inverter. Do not attempt to service the unit yourself.

Battery Maintenance

- Servicing of batteries should be performed or supervised by personnel knowledgeable about batteries and the required precautions.
- When replacing batteries, replace with the same type and number of batteries or battery packs.
- The following precautions should be observed when working on batteries:
 - a) Remove watches, rings, or other metal objects.
 - b) Use tools with insulated handles.
 - c) Wear rubber gloves and boots.
 - d) Do not lay tools or metal parts on top of batteries.
 - e) Disconnect charging source prior to connecting or disconnecting battery terminals.
 - f) Determine if battery is inadvertently grounded. If inadvertently grounded, remove source from ground. Contact with any part of a grounded battery can result in electrical shock. The likelihood of such shock can be reduced if such grounds are removed during installation and maintenance (applicable to equipment and remote battery supplies not having a grounded supply circuit).

CAUTION: A battery can present a risk of electrical shock and high short-circuit current.

CAUTION: Do not dispose of batteries in a fire. The batteries may explode.

CAUTION: Do not open or mutilate batteries. Released electrolyte is harmful to the skin and eyes. It may be toxic.

15. Trouble Shooting

When there is no information displayed in the LCD, please check if PV module/battery/grid connection is correctly connected.

NOTE: The warning and fault information can be recorded by remote monitoring software.

15.1. Warning List

There are 17 situations defined as warnings. When a warning situation occurs, "Warning Event" icon will flash. If there are several codes, it will display in sequences. Please contact your installer when you couldn't handle with the warning situations.

HYBRID INVERTER 17:30 2017/7/28 AC GRID: R: 230.0V/10.0A S: 230.0V/10.0A T: 230.0V/10.0A Frequency: 50.0Hz WR:LineHLoss 2/10

Code	Warning Event	Description
01	BatOpen	Battery is unconnected or too low.
02	LineHLoss	Grid voltage is too high.
03	LineLLoss	Grid voltage is too low.
04	LineFreqHLoss	Grid frequency is too high.
05	LineFreqLLoss	Grid frequency is too low.
06	LineLTLoss	Grid voltage is higher than 253V.
07	GroundLoss	Ground wire is not detected.
08	LineislandDetect	Island operation is detected.
09	LineWaveLoss	The waveform of grid is not suitable for inverter.
10	LinePhaseLoss	The Phase sequence of grid is not suitable for inverter.
11	EPODetect	EPO is open.
12	Overload	Load exceeds rating value.
13	DCDCOverTemp	The temperature is too high inside.
14	BatLow	Battery discharges to low alarm point.
15	BatUnder	Battery discharges to shutdown point.
16	BatWeek	Battery stops discharging when the grid is OK.
17	SolarLoss	PV voltage is too low.
18	Inv0TempOver	The temperature is too high inside.
19	OPSCRTempOver	The temperature is too high inside.
20	Inv1TempOver	The temperature is too high inside.
21	BatSCRTempOver	The temperature is too high inside.

15.2. Fault Reference Codes

When a fault occurs, the icon “**Fault Event**” will flash as a reminder. See below for fault codes for reference.

Code	Fault Event	Possible cause	Solution
01	Bus voltage over	Surge	1. Restart the inverter. 2. If the error message still remains, please contact your installer.
02	BUS voltage under	PV or battery disconnect suddenly	1. Restart the inverter 2. If the error message still remains, please contact your installer.
03	BUS soft start time out	Internal components failed.	Please contact your installer.
04	INV soft start time out	Internal components failed.	Please contact your installer.
05	INV Curr over	Surge	1. Restart the inverter. 2. If the error message still remains, please contact your installer.
06	R SCR Close Fault	Internal components failed.	Please contact your installer.
07	S SCR Close Fault		
08	T SCR Close Fault		
09	Solar Power abnor	Solar input voltage is too high	1. Please check if solar input voltage is higher than 950V. 2. Please contact your installer.
11	Solar IP Curr over	Surge	1. Restart the inverter. 2. If the error message still remains, please contact your installer.
16	GFCI Senser fault	Internal components failed	Please contact your installer.
17	Mcu&Dsp com loss	Firmware version not compatible	please contact your installer.
18	Mcu&Dsp ver error		
22	Bat volt over	Battery voltage exceeds the limit.	1. Check the battery voltage. 2. If the error message still remains, please contact your installer.

23	Over load	The inverter is loaded with more than 110% load and time is up	Reduced the connected load by switching off some equipment.
24	R SCR Open Fault	Internal components failed.	Please contact your installer.
25	S SCR Open Fault		
26	T SCR Open Fault		
32	DCDC curr over	Load fluctuates	1. Restart the inverter. 2. If the error message still
33	Inv Volt Low	Internal components failed.	Please contact your installer.
34	Inv Volt High		
36	OP Circuit Fault	Grid connects to output terminal	Don't connect the grid to the output terminal.
40	Inv R Short	Output short circuited	1. Check if wiring is connected well and remove abnormal load. 2. If the error message still remains, please contact your installer.
41	Inv S Short		
42	Inv T Short		
43	Inv R/S short		
44	Inv S/T short		
45	Inv T/R short		
46	Trans Temp Over	The temperature is too high inside.	1. Check the ambient temperature and fans. 2. If the error message still remains, please contact your installer.
47	DCDC Temp Over		
48	Inv Temp Over		
49	Inv1 Temp Over		
50	OP SCR Temp Over		
51	Bat SCR Temp Over		
52	Bat Curr Avg CT	Internal components failed.	Please contact your installer.
53	Bat Curr CT Fault		
54	R INV Curr CT		
55	S INV Curr CT		
56	T INV Curr CT		
57	R OP Volt CT		
58	S OP Volt CT		
59	T OP Volt CT	Surge	1. Restart the inverter. 2. If the error message still remains, please contact your installer.
61	R Inv Cur FW Over		
62	S Inv Cur FW Over		

63	T Inv Cur FW Over	Surge	<ol style="list-style-type: none"> 1. Restart the inverter. 2. If the error message still remains, please contact your installer.
64	R Inv Cur HW Over		
65	S Inv Cur HW Over		
66	T Inv Cur HW Over		
67	DCDC Buck Fault	Load fluctuates	<ol style="list-style-type: none"> 1. Restart the inverter. 2. If the error message still remains, please contact your installer.
68	DCDC Boost Fault		
71	Para Version Diff		<ol style="list-style-type: none"> 1. Update all inverter firmware to the same version. 2. Check the version of each inverter via LCD setting and make sure the CPU versions are same. If not, please contact your installer to provide the firmware to update. 3. After updating, if the problem still remains, please contact your installer.
72	OP Curr Cir Fault		<ol style="list-style-type: none"> 1. Check if sharing cables are connected well and restart the inverter. 2. If the problem remains, please contact your installer.
80	Can Comm Fail		<ol style="list-style-type: none"> 1. Check if communication cables are connected well and restart the inverter. 2. If the problem remains, please contact your installer.
81	Para HOST Loss		
82	Para SYN Loss		

16. Specifications

MODEL	30KW
RATED POWER	30000 W
PV INPUT (DC)	
Maximum DC Power	45000 W
Nominal DC Voltage	720 VDC
Maximum DC Voltage	950 VDC
Working DC Voltage Range	450 VDC ~ 950 VDC
Start-up Voltage / Initial Feeding Voltage	500Vdc \pm 10% / 550V \pm 10VDC
MPP Voltage Range	460 VDC ~ 900 VDC
Full Load MPP Voltage Range	625 VDC ~ 900 VDC
Maximum Input Current	72 A
Max. inverter back feed current to the array	0 A
GRIDOUTPUT (AC)	
Nominal Output Voltage	230 VAC
Output Voltage Range	195.5 - 253 VAC
Output Frequency Range	49 ~ 51 Hz or 59.3~ 60.5Hz
Nominal Output Current	43.5 A per phase
Maximum Output Fault Current/Duration	250 A / 1ms
Maximum output Overcurrent Protection	150 A
Power Factor Range	1
AC INPUT	
Auto Restart Voltage	180 VAC
Acceptable Input Voltage Range	170 - 280 VAC
Nominal Frequency	50 Hz / 60 Hz
AC Input Power	30000VA/30000W
Maximum AC Input Current	43.5 A per phase
BATTERY MODE OUTPUT (AC)	
Nominal Output Voltage	230 VAC
Output Frequency	50 Hz / 60 Hz (auto sensing)
Output Waveform	Pure sine wave
Output Power	30000VA/30000W
Efficiency (DC to AC)	91%
BATTERY & CHARGER (Lead-acid/Li-ion)	
DC Working Voltage Range	320-512VDC
DC Charging Voltage Range	384-480VDC
Nominal DC Voltage	384 VDC
Maximum Battery Discharging Current	150A
Maximum Charging Current	80 A

GENERAL	
PHYSICAL	
Dimension, (W x D x H)(mm)	430 x 715 x 1021
Net Weight (kgs)	223
INTERFACE	
Communication Port	RS-232/USB
Intelligent Slot	Optional SNMP, GRPS, WIFI, Modbus cards available
ENVIRONMENT	
Protective Class	I
Ingress Protection Rating	IP20
Humidity	0 ~ 90% RH (No condensing)
Operating Temperature	-10 to 55°C (Power derating above 50°C)
Altitude	Max. 2000m*

* Power derating 1% every 100m when altitude is over 1000m.

17. Parallel Function

Please refer to below wiring diagram for parallel operation.

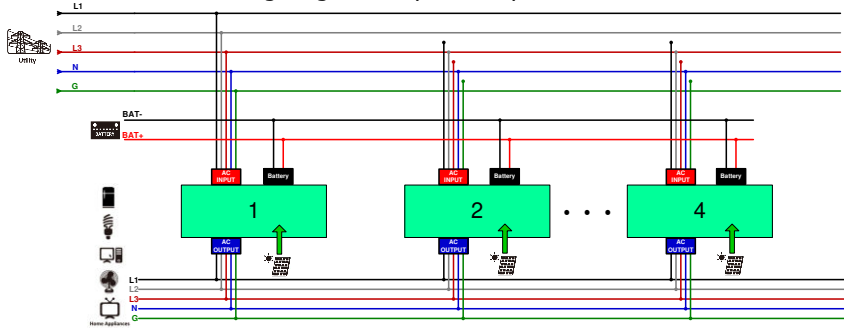

Parallel function	
Max. parallel numbers	4
Parallel System Output Power	Max. 120KVA/120KW
Circulation Current under No Load Condition	Max 10A
Power Unbalance Ratio	<5% @ 100% Load
Parallel communication	CAN
Transfer time in parallel mode	Max 50ms