

User Manual



**Direct Solar 3.6KW / Direct Solar 5.6KW
SOLAR INVERTER / CHARGER**

Table of Contents

ABOUT THIS MANUAL	1
Purpose.....	1
Scope.....	1
SAFETY INSTRUCTIONS.....	1
INTRODUCTION	2
Features	2
Basic System Architecture	2
Product Overview.....	3
Unpacking and Inspection	4
Preparation	4
Mounting the Unit.....	4
Battery Connection	5
AC Input/Output Connection.....	6
PV Connection	7
Final Assembly.....	9
Communication Connection.....	9
Dry Contact Signal.....	10
OPERATION.....	11
Power ON/OFF	11
Operation and Display Panel	11
LCD Display Icons	12
LCD Setting.....	15
LCD Display	31
Operating Mode Description	36
Faults Reference Code	40
Warning Indicator.....	41
CLEARANCE AND MAINTENANCE FOR ANTI-DUST KIT	42
Overview	42
Clearance and Maintenance.....	42
BATTERY EQUALIZATION	43
SPECIFICATIONS.....	44
Table 1 Line Mode Specifications	44
Table 2 Inverter Mode Specifications	45
Table 3 Charge Mode Specifications.....	46
Table 4 General Specifications.....	46
TROUBLE SHOOTING	47
Appendix I: BMS Communication Installation.....	48
Appendix II: The Wi-Fi Operation Guide.....	55

ABOUT THIS MANUAL

Purpose

This manual describes the assembly, installation, operation and troubleshooting of this unit. Please read this manual carefully before installations and operations. Keep this manual for future reference.

Scope

This manual provides safety and installation guidelines as well as information on tools and wiring.

SAFETY INSTRUCTIONS

⚠ WARNING: This chapter contains important safety and operating instructions. Read and keep this manual for future reference.

1. Before using the unit, read all instructions and cautionary markings on the unit, the batteries and all appropriate sections of this manual.
2. **CAUTION** – To reduce risk of injury, charge only deep-cycle lead acid type rechargeable batteries. Other types of batteries may burst, causing personal injury and damage.
3. Do not disassemble the unit. Take it to a qualified service center when service or repair is required. Incorrect re-assembly may result in a risk of electric shock or fire.
4. To reduce risk of electric shock, disconnect all wirings before attempting any maintenance or cleaning. Turning off the unit will not reduce this risk.
5. **CAUTION** – Only qualified personnel can install this device with battery.
6. **NEVER** charge a frozen battery.
7. For optimum operation of this inverter/charger, please follow required spec to select appropriate cable size. It's very important to correctly operate this inverter/charger.
8. Be very cautious when working with metal tools on or around batteries. A potential risk exists to drop a tool to spark or short circuit batteries or other electrical parts and could cause an explosion.
9. Please strictly follow installation procedure when you want to disconnect AC or DC terminals. Please refer to INSTALLATION section of this manual for the details.
10. Fuses are provided as over-current protection for the battery supply.
11. GROUNDING INSTRUCTIONS -This inverter/charger should be connected to a permanent grounded wiring system. Be sure to comply with local requirements and regulation to install this inverter.
12. NEVER cause AC output and DC input short circuited. Do NOT connect to the mains when DC input short circuits.
13. **Warning!!** Only qualified service persons are able to service this device. If errors still persist after following troubleshooting table, please send this inverter/charger back to local dealer or service center for maintenance.
14. **WARNING:** Because this inverter is non-isolated, only three types of PV modules are acceptable: single crystalline, poly crystalline with class A-rated and CIGS modules. To avoid any malfunction, do not connect any PV modules with possible current leakage to the inverter. For example, grounded PV modules will cause current leakage to the inverter. When using CIGS modules, please be sure NO grounding.
15. **CAUTION:** It's required to use PV junction box with surge protection. Otherwise, it will cause damage on inverter when lightning occurs on PV modules.

INTRODUCTION

This is a multi-function inverter, combining functions of inverter, solar charger and battery charger to offer uninterruptible power support in a single package. The comprehensive LCD display offers user-configurable and easy-accessible button operations such as battery charging current, AC or solar charging priority, and acceptable input voltage based on different applications.

Features

- Pure sine wave inverter
- Customizable status LED ring with RGB lights
- Touchable button with 4.3" colored LCD
- Built-in Wi-Fi for mobile monitoring (APP is required)
- Supports USB On-the-Go function
- Built-in anti-dusk kit
- Reserved communication ports for BMS (RS485, CAN-BUS, RS232)
- Configurable input voltage ranges for home appliances and personal computers via LCD control panel
- Configurable output usage timer and prioritization
- Configurable charger source priority via LCD control panel
- Configurable battery charging current based on applications via LCD control panel
- Compatible to utility mains or generator power

Basic System Architecture

The following illustration shows basic application for this unit. It also required the following devices to have a complete running system:

- Generator or Utility mains.
- PV modules

Consult with your system integrator for other possible system architectures depending on your requirements.

This inverter can power various appliances in home or office environment, including motor-type appliances such as tube light, fan, refrigerator and air conditioners.

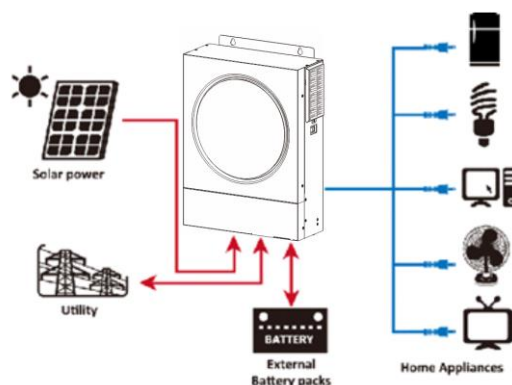
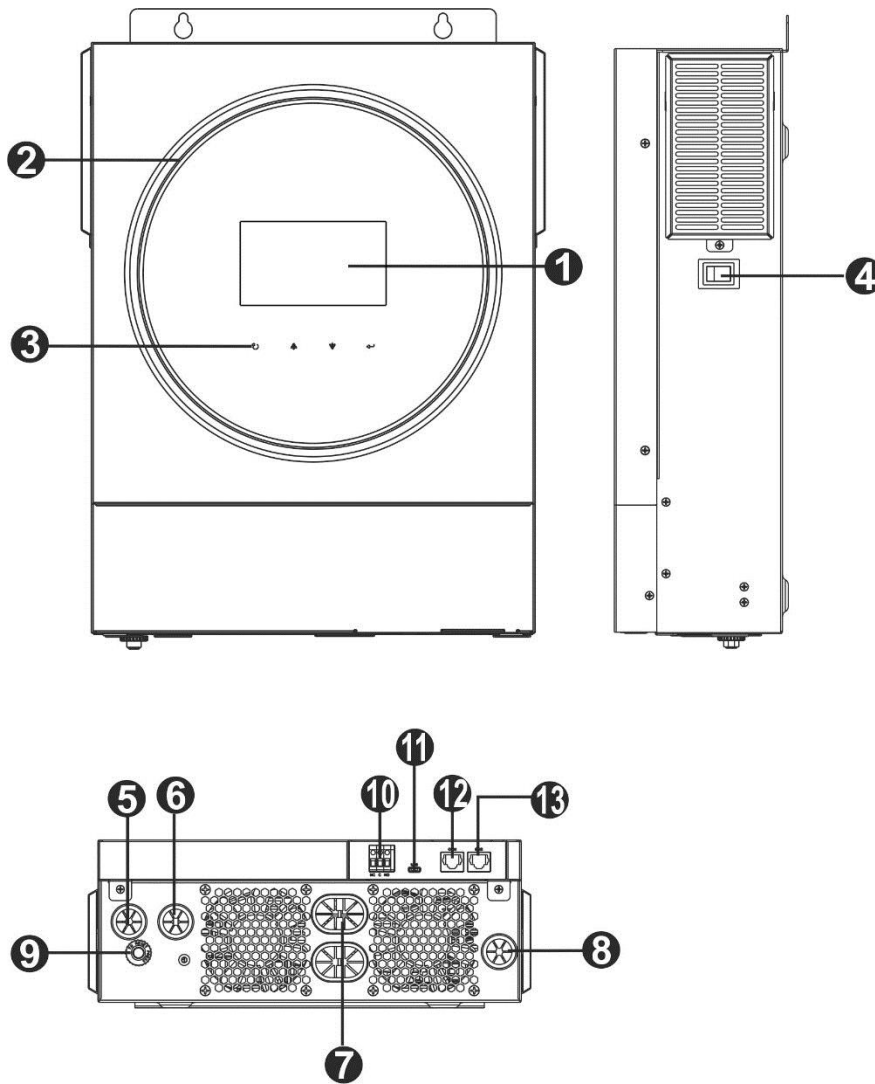

Figure 1 Basic hybrid PV System Overview

Product Overview



1. LCD display
2. RGB LED bar (refer to LCD Setting section for the details)
3. Touchable function keys
4. Power on/off switch
5. AC input connectors
6. AC output connectors (Load connection)
7. Battery connectors
8. PV connectors
9. Circuit breaker
10. Dry contact
11. USB port as USB communication port and USB function port
12. RS-232 communication port
13. BMS communication port: CAN, RS-485 or RS-232

INSTALLATION

Unpacking and Inspection

Before installation, please inspect the unit. Be sure that nothing inside the package is damaged. You should have received the following items inside of package:

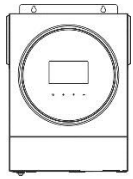

Inverter unit



Manual



software CD



RS-232 cable

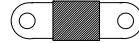

DC Fuse

Preparation

Before connecting all wirings, please take off bottom cover by removing two screws. When removing the bottom cover, be carefully to remove one cable as shown below.

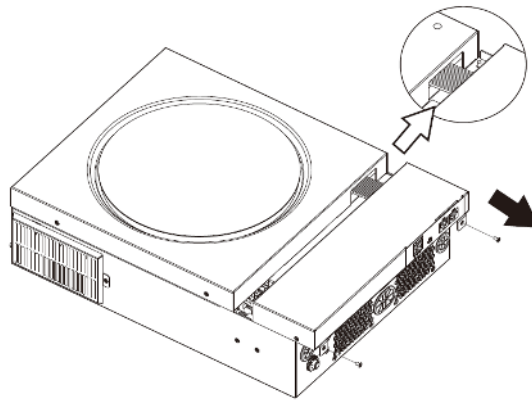

Mounting the Unit

Consider the followings before selecting your placements:

- Do not mount the inverter on flammable construction materials.
- Mount on a solid surface
- Install the inverter at eye level in order to allow easy LCD display readout.
- For proper air circulation and heat dissipation, allow a clearance of approx. 20 cm to the side and approx. 50 cm above and below the unit.
- The ambient temperature should be between 0°C and 55°C to ensure optimal operation.
- The recommended orientation is to adhered to the wall vertically.

Be sure to keep other objects and surfaces as shown in the diagram to guarantee sufficient heat dissipation and to have enough space for wirings.

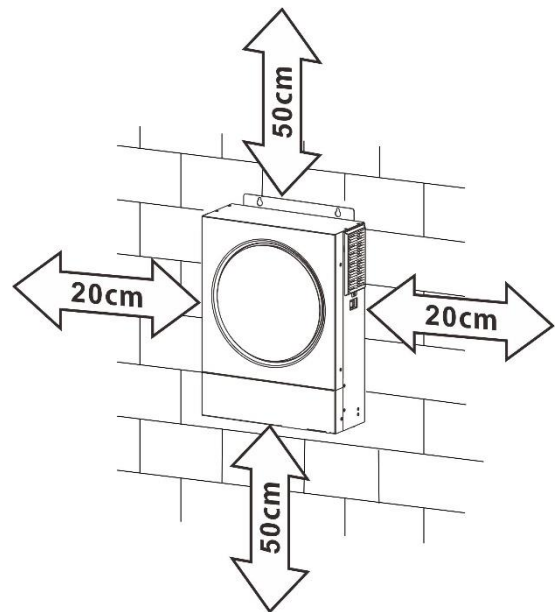

⚠ SUITABLE FOR MOUNTING ON CONCRETE OR OTHER NON-COMBUSTIBLE SURFACE ONLY.

Install the unit by screwing three screws. It's recommended to use M4 or M5 screws.

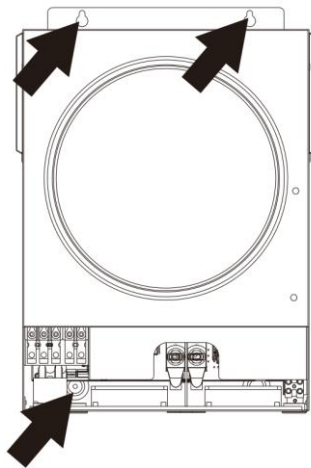

Battery Connection

CAUTION: For safety operation and regulation compliance, it's requested to install a separate DC over-current protector or disconnection device between battery and the inverter. It may not be necessary to have a disconnection device in some applications, however, it's still recommended to have over-current protection installed. Please refer to typical amperage as required.

WARNING! All wiring must be performed by a qualified personnel.

WARNING! It's very important for system safety and efficient operation to use appropriate cable for battery connection. To reduce risk of injury, please use the proper recommended cable and terminal size as below.

Ring terminal:

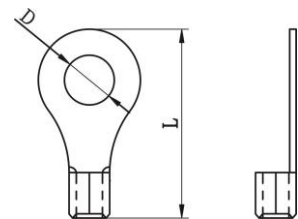

Recommended battery cable and terminal size:

Model	Typical Amperage	Wire Size	Cable mm ²	Ring Terminal Dimensions		Torque Value
				D (mm)	L (mm)	
				Direct Solar 3.6KW	166.7A	
Direct Solar 5.6KW	129.6A	2*2AWG or 4*4AWG	38 or 25	8.4	39.2 or 33.2	

Please follow below steps to implement battery connection:

1. Direct Solar 3.6KW model supports 24VDC system and Direct Solar 5.6KW model supports 48VDC system. Connect all battery packs as below chart. It is recommend to connect minimum of 100Ah capacity battery for Direct Solar 3.6KW model and 200Ah capacity battery for Direct Solar 5.6KW model.

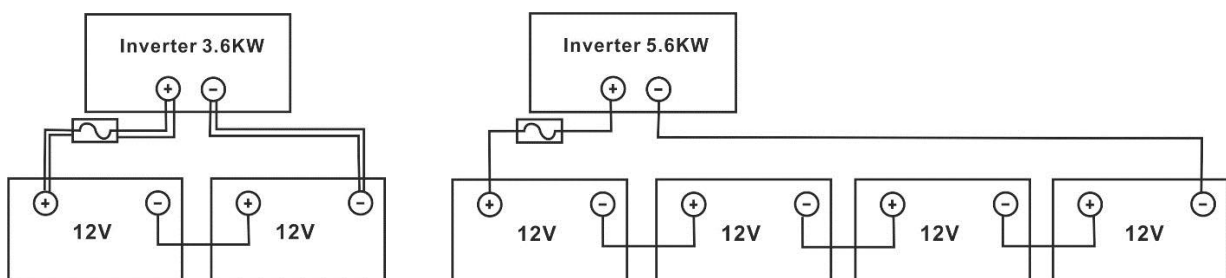

2. Prepare four battery wires for Direct Solar 3.6KW model and two or four battery wires for Direct Solar 5.6KW model depending on cable size (refer to recommended cable size table). Apply ring terminals to your battery wires and secure it to the battery terminal block with the bolts properly tightened. Refer to battery cable size for torque value. Make sure polarity at both the battery and the inverter is correctly

connected and ring terminals are secured to the battery terminals.

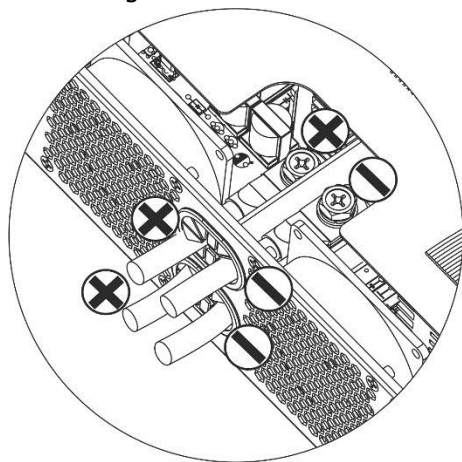

Direct Solar 3.6KW
(using two battery wires)

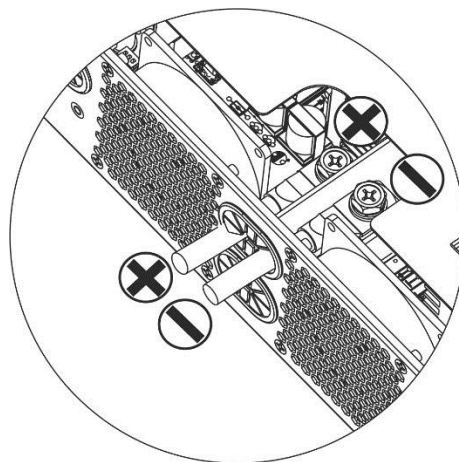

Direct Solar 5.6KW

 **WARNING: Shock Hazard**
Installation must be performed with care due to high battery voltage in series.

 **CAUTION!!** Do not place anything between the flat part of the inverter terminal and the ring terminal. Otherwise, overheating may occur.
CAUTION!! Do not apply anti-oxidant substance on the terminals before terminals are connected tightly.
CAUTION!! Before making the final DC connection or closing DC breaker/disconnector, be sure positive (+) must be connected to positive (+) and negative (-) must be connected to negative (-).

AC Input/Output Connection

CAUTION!! Before connecting to AC input power source, please install a **separate** AC breaker between inverter and AC input power source. This will ensure the inverter can be securely disconnected during maintenance and fully protected from over current of AC input. The recommended spec of AC breaker is 32A for Direct Solar 3.6KW and 50A for Direct Solar 5.6KW.

CAUTION!! There are two terminal blocks with "IN" and "OUT" markings. Please do NOT mis-connect input and output connectors.

WARNING! All wiring must be performed by a qualified personnel.

WARNING! It's very important for system safety and efficient operation to use appropriate cable for AC input connection. To reduce risk of injury, please use the proper recommended cable size as below.

Suggested cable requirement for AC wires

Model	Gauge	Cable (mm ²)	Torque Value
Direct Solar 3.6KW	12 AWG	4	1.2 Nm
Direct Solar 5.6KW	10 AWG	6	1.2 Nm

Please follow below steps to implement AC input/output connection:

1. Before making AC input/output connection, be sure to open DC protector or disconnector first.
2. Remove insulation sleeves for about 10mm for the five screw terminals.
3. Insert AC input wires according to polarities indicated on terminal block and tighten the terminal screws.

Be sure to connect PE protective conductor (⊕) first.

- ⊕ → **Ground (yellow-green)**
- L → **LINE (brown or black)**
- N → **Neutral (blue)**

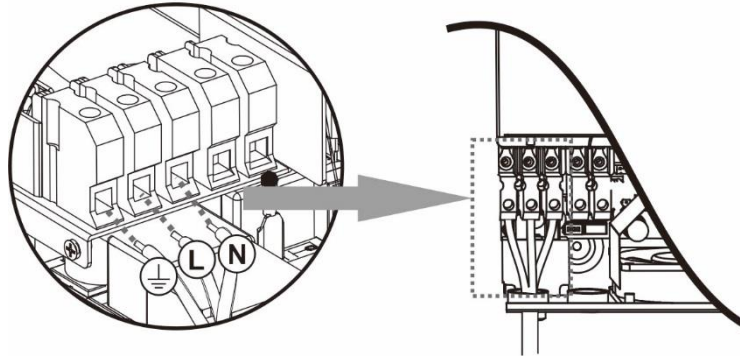

WARNING: Be sure that AC power source is disconnected before attempting to hardwire it to the unit.

4. Then, insert AC output wires according to polarities indicated on terminal block and tighten terminal screws. Be sure to connect PE protective conductor (⊕) first.

⊕ → **Ground (yellow-green)**
L → **LINE (brown or black)**
N → **Neutral (blue)**

5. Make sure the wires are securely connected.

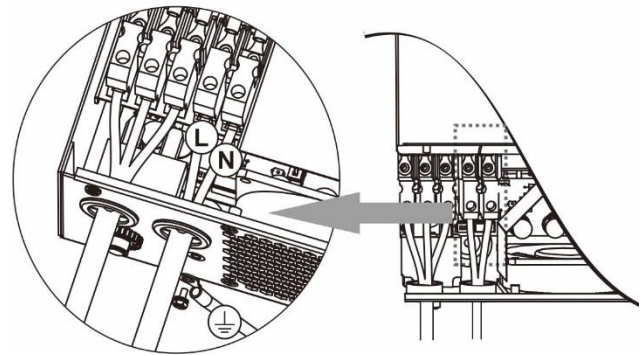

CAUTION: Appliances such as air conditioner requires at least 2~3 minutes to restart because it's required to have enough time to balance refrigerant gas inside of circuits. If a power shortage occurs and recovers in a short time, it will cause damage to your connected appliances. To prevent this kind of damage, please check manufacturer of air conditioner if it's equipped with time-delay function before installation. Otherwise, this inverter/charger will be trigger overload fault and cut off output to protect your appliance but sometimes it still causes internal damage to the air conditioner.

PV Connection

CAUTION: Before connecting to PV modules, please install **separately** DC circuit breakers between inverter and PV modules.

WARNING! It's very important for system safety and efficient operation to use appropriate cable for PV module connection. To reduce risk of injury, please use the proper recommended cable size shown below.

Model	Wire Size	Cable (mm ²)	Torque value (max)
Direct Solar 3.6KW Direct Solar 5.6KW	1 x 12AWG	4	1.2 Nm

WARNING: Because this inverter is non-isolated, are accepted: single crystalline, poly crystalline with class A-rated and CIGS modules. To avoid any malfunctions, do not connect any PV modules with possible current leakage to the inverter. For example, grounded PV modules will cause current leakage to the inverter. When using CIGS modules, please be sure NO grounding connection.

CAUTION: It's requested to use PV junction box with surge protection. Otherwise, it will cause damage on inverter when lightning occurs on PV modules.

PV Module Selection:

When selecting proper PV modules, please be sure to consider the following parameters:

1. Open circuit Voltage (Voc) of PV modules not to exceeds maximum PV array open circuit voltage of the inverter.
2. Open circuit Voltage (Voc) of PV modules should be higher than the start-up voltage.

INVERTER MODEL	Direct Solar 3.6KW	Direct Solar 5.6KW
Max. PV Array Power	4000W	6000W
Max. PV Array Open Circuit Voltage	500Vdc	
PV Array MPPT Voltage Range	120Vdc~450Vdc	
Start-up Voltage	150Vdc +/- 10Vdc	

Take the 250Wp PV module as an example. After considering above two parameters, the recommended module configurations are listed in the table below.

Solar Panel Spec. (reference)	SOLAR INPUT		Q'ty of panels	Total input power
	Min in series: 6 pcs, max. in series: 12 pcs.			
- 250Wp	6 pcs in series		6 pcs	1500W
- Vmp: 30.1Vdc	8 pcs in series		8 pcs	2000W
- Imp: 8.3A	12 pcs in series		12 pcs	3000W
- Voc: 37.7Vdc	8 pieces in series and 2 sets in parallel		16 pcs	4000W
- Isc: 8.4A	10 pieces in series and 2 sets in parallel (only for 5.6KVA model)		20 pcs	5000W
- Cells: 60	11 pieces in series and 2 sets in parallel (only for 5.6KVA model)		22 pcs	5500W
	12 pieces in series and 2 sets in parallel (only for 5.6KVA model)		24 pcs	6000W

PV Module Wire Connection

Please take the following to implement PV module connection:

1. Remove insulation sleeve for about 7 mm on your positive and negative wires.
2. We recommend using bootlace ferrules on the wires for optimal performance.
3. Check polarities of wire connections from PV modules to PV input screw terminals. Connect your wires as illustrated below.

Recommended tool: 4mm blade screwdriver

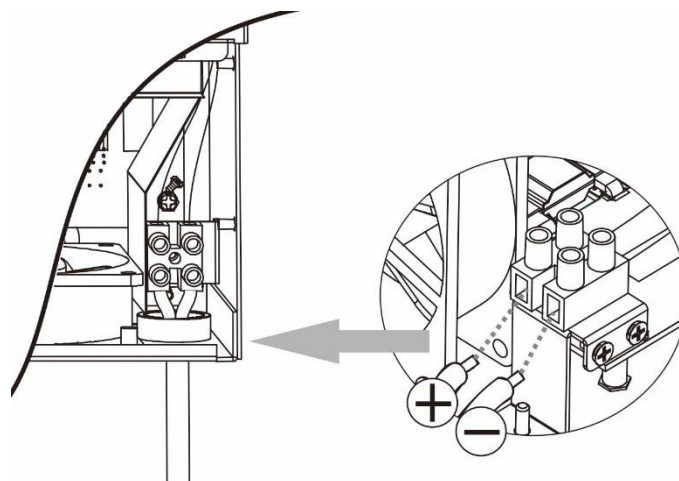

Final Assembly

After connecting all wirings, re-connect one cable and then put bottom cover back by screwing two screws as shown below.

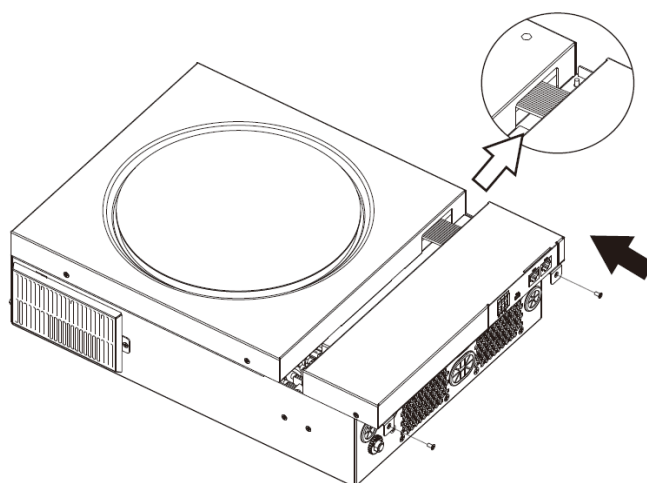

Communication Connection

Follow below chart to connect all communication wiring.

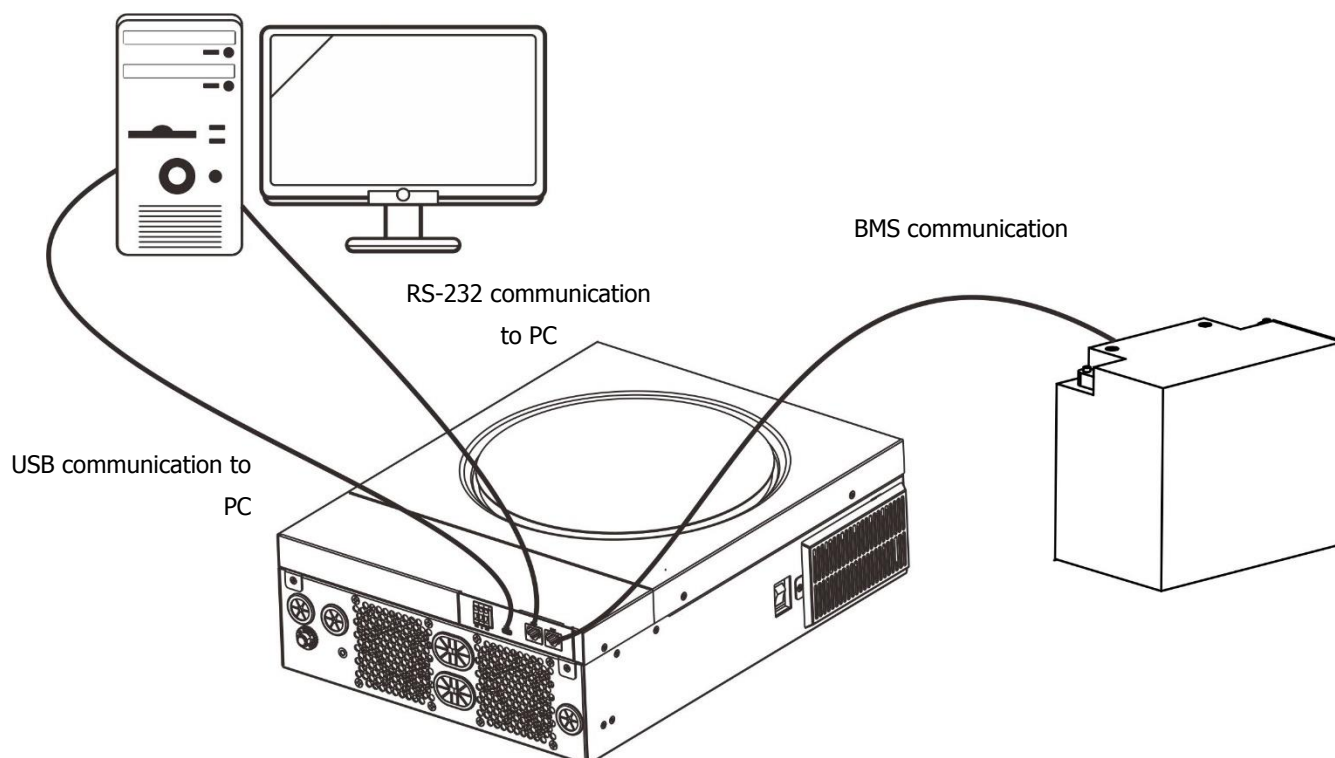

Serial Connection

Please use the supplied serial cable to connect between the inverter and your PC. Install the monitoring software from the bundled CD and follow the on-screen instructions to complete your installation. For detailed software operation, refer to the software user manual on the bundled CD.

Wi-Fi Connection

This unit is equipped with a Wi-Fi transmitter. Wi-Fi transmitter can enable wireless communication between off-grid inverters and monitoring platform. Users can access and control the monitored inverter with downloaded APP. You may find "WatchPower" app from the Apple® Store or "WatchPower Wi-Fi" in Google® Play Store. All data loggers and parameters are saved in iCloud. For quick installation and operation, please

refer to Appendix III - The Wi-Fi Operation Guide for details.

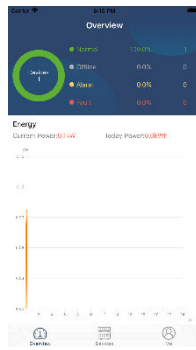

BMS Communication Connection

It is recommended to purchase a special communication cable if you are connecting to Lithium-Ion battery banks. Please refer to Appendix II - BMS Communication Installation for details.

Dry Contact Signal

There is one dry contact (3A/250VAC) available on the rear panel. It could be used to deliver signal to external device when battery voltage reaches warning level.

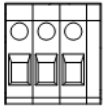
Unit Status	Condition		Dry contact port: 		
			NC & C	NO & C	
Power Off	Unit is off and no output is powered.		Close	Open	
Power On	Output is powered from Battery power or Solar energy.	Program 01 set as USB (utility first) or SUB (solar first)	Battery voltage < Low DC warning voltage	Open	Close
			Battery voltage > Setting value in Program 13 or battery charging reaches floating stage	Close	Open
		Program 01 is set as SBU (SBU priority)	Battery voltage < Setting value in Program 12	Open	Close
			Battery voltage > Setting value in Program 13 or battery charging reaches floating stage	Close	Open

OPERATION

Power ON/OFF

Once the unit has been properly installed and the batteries are connected well, simply press On/Off switch (on the side of the inverter) to turn on the unit.



Operation and Display Panel

The operation LCD panel, shown in the chart below, includes one RGB LED ring, four touchable function keys and a LCD display to indicate the operating status and input/output power information.

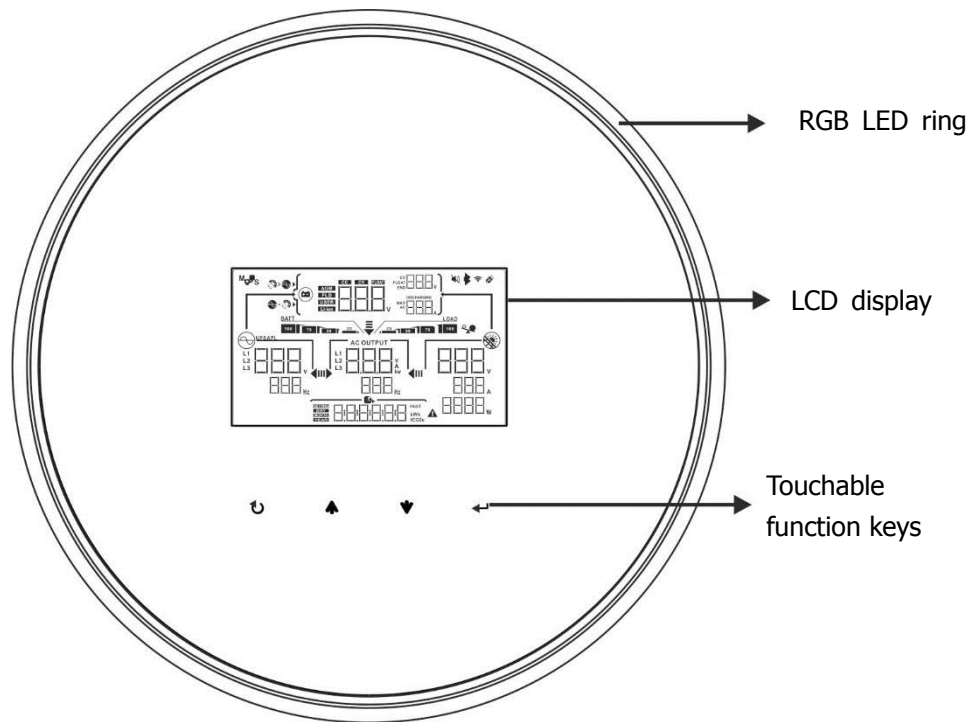







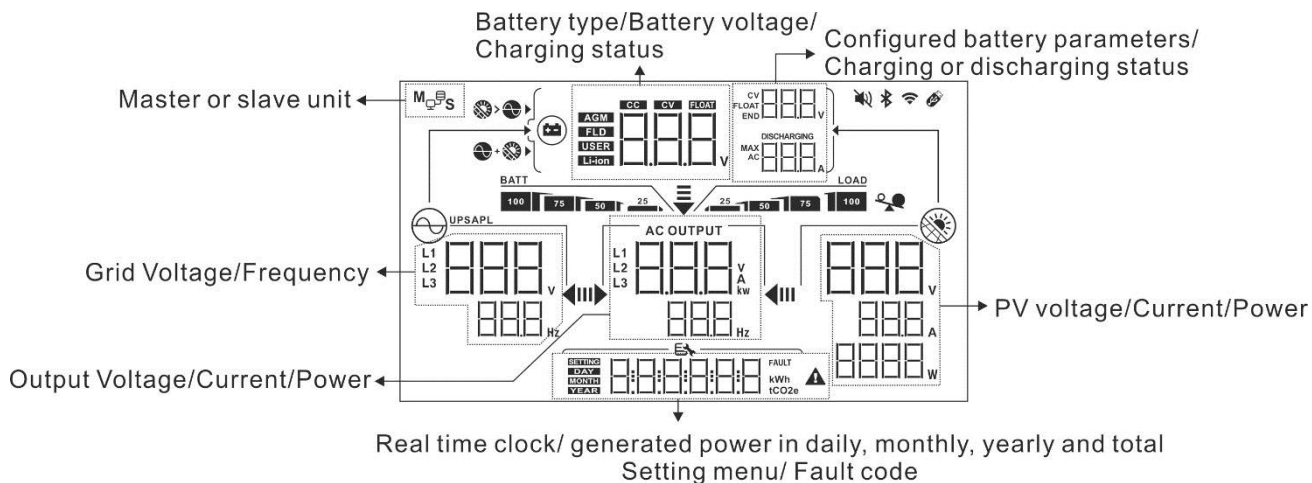



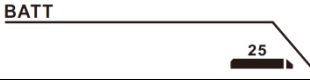



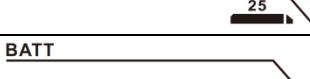



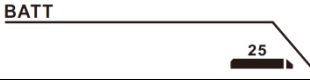



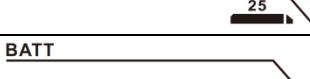



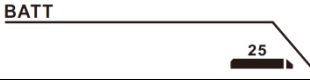



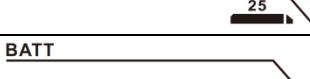









Touchable Function Keys







Function Key		Description
↶	ESC	To exit the setting
	Access USB setting mode	To enter USB setting mode
▲	Up	To last selection
▼	Down	To next selection
↵	Enter	To confirm/enter the selection in setting mode

LCD Display Icons

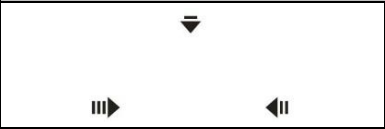
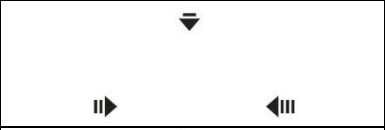

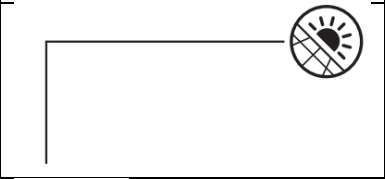
Icon	Function description
Input Source Information	
	Indicates the AC input voltage and frequency.
	Indicates the PV voltage, current and power.
	Indicates the battery voltage, charging stage, configured battery parameters, charging or discharging current.
Configuration Program and Fault Information	
	Indicates the setting programs.
	Indicates the warning and fault codes. Warning: 000 flashing with warning code. Fault: 000 lighting with fault code.
Output Information	
	Indicate the output voltage, load in VA, and load in Watt and output frequency.
Battery Information	

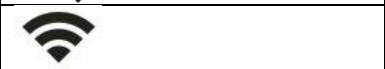
	Indicates battery level by 0-24%, 25-49%, 50-74% and 75-100% in battery mode and charging status in line mode.																						
When battery is charging, it will present battery charging status.																							
<table border="1"> <tr> <th>Status</th> <th>Battery voltage</th> <th>LCD Display</th> </tr> <tr> <td rowspan="4">Constant Current mode / Constant Voltage mode</td> <td><2V/cell</td> <td>4 bars will flash in turns.</td> </tr> <tr> <td>2 ~ 2.083V/cell</td> <td>The right bar will be on and the other three bars will flash in turns.</td> </tr> <tr> <td>2.083 ~ 2.167V/cell</td> <td>The right two bars will be on and the other two bars will flash in turns.</td> </tr> <tr> <td>> 2.167 V/cell</td> <td>The right three bars will be on and the left bar will flash.</td> </tr> <tr> <td colspan="2">Floating mode. Batteries are fully charged.</td> <td>4 bars will be on.</td> </tr> </table>	Status	Battery voltage	LCD Display	Constant Current mode / Constant Voltage mode	<2V/cell	4 bars will flash in turns.	2 ~ 2.083V/cell	The right bar will be on and the other three bars will flash in turns.	2.083 ~ 2.167V/cell	The right two bars will be on and the other two bars will flash in turns.	> 2.167 V/cell	The right three bars will be on and the left bar will flash.	Floating mode. Batteries are fully charged.		4 bars will be on.								
Status	Battery voltage	LCD Display																					
Constant Current mode / Constant Voltage mode	<2V/cell	4 bars will flash in turns.																					
	2 ~ 2.083V/cell	The right bar will be on and the other three bars will flash in turns.																					
	2.083 ~ 2.167V/cell	The right two bars will be on and the other two bars will flash in turns.																					
	> 2.167 V/cell	The right three bars will be on and the left bar will flash.																					
Floating mode. Batteries are fully charged.		4 bars will be on.																					
In battery mode, it will present battery capacity.																							
<table border="1"> <thead> <tr> <th>Load Percentage</th> <th>Battery Voltage</th> <th>LCD Display</th> </tr> </thead> <tbody> <tr> <td rowspan="4">Load >50%</td> <td>< 1.85V/cell</td> <td></td> </tr> <tr> <td>1.85V/cell ~ 1.933V/cell</td> <td></td> </tr> <tr> <td>1.933V/cell ~ 2.017V/cell</td> <td></td> </tr> <tr> <td>> 2.017V/cell</td> <td></td> </tr> <tr> <td rowspan="4">Load < 50%</td> <td>< 1.892V/cell</td> <td></td> </tr> <tr> <td>1.892V/cell ~ 1.975V/cell</td> <td></td> </tr> <tr> <td>1.975V/cell ~ 2.058V/cell</td> <td></td> </tr> <tr> <td>> 2.058V/cell</td> <td></td> </tr> </tbody> </table>	Load Percentage	Battery Voltage	LCD Display	Load >50%	< 1.85V/cell		1.85V/cell ~ 1.933V/cell		1.933V/cell ~ 2.017V/cell		> 2.017V/cell		Load < 50%	< 1.892V/cell		1.892V/cell ~ 1.975V/cell		1.975V/cell ~ 2.058V/cell		> 2.058V/cell			
Load Percentage	Battery Voltage	LCD Display																					
Load >50%	< 1.85V/cell																						
	1.85V/cell ~ 1.933V/cell																						
	1.933V/cell ~ 2.017V/cell																						
	> 2.017V/cell																						
Load < 50%	< 1.892V/cell																						
	1.892V/cell ~ 1.975V/cell																						
	1.975V/cell ~ 2.058V/cell																						
	> 2.058V/cell																						
Load Information																							
	Indicates overload.																						
	<table border="1"> <tr> <td colspan="2" data-bbox="587 1406 1002 1467">Indicates the load level by 0-24%, 25-49%, 50-74% and 75-100%.</td> </tr> <tr> <td data-bbox="587 1467 1002 1512">0%~24%</td> <td data-bbox="1002 1467 1433 1512">25%~49%</td> </tr> <tr> <td data-bbox="587 1512 1002 1590"></td> <td data-bbox="1002 1512 1433 1590"></td> </tr> <tr> <td data-bbox="587 1590 1002 1635">50%~74%</td> <td data-bbox="1002 1590 1433 1635">75%~100%</td> </tr> <tr> <td data-bbox="587 1635 1002 1713"></td> <td data-bbox="1002 1635 1433 1713"></td> </tr> </table>		Indicates the load level by 0-24%, 25-49%, 50-74% and 75-100%.		0%~24%	25%~49%			50%~74%	75%~100%													
Indicates the load level by 0-24%, 25-49%, 50-74% and 75-100%.																							
0%~24%	25%~49%																						
																							
50%~74%	75%~100%																						
																							
Charger Source Priority Setting Display																							
	Indicates setting program 16 "Charger source priority" is selected as "Solar first".																						
	Indicates setting program 16 "Charger source priority" is selected as "Solar and Utility".																						
	Indicates setting program 16 "Charger source priority" is selected as "Solar only".																						





Output source priority setting display	
	Indicates setting program 01 "Output source priority" is selected as "Utility first".
	Indicates setting program 01 "Output source priority" is selected as "Solar first".
	Indicates setting program 01 "Output source priority" is selected as "SBU".
AC Input Voltage Range Setting Display	
UPS	Indicates setting program 03 is selected as "UPS". The acceptable AC input voltage range will be within 170-280VAC.
APL	Indicates setting program 03 is selected as "APL". The acceptable AC input voltage range will be within 90-280VAC.
Operation Status Information	
	Indicates unit connects to the mains.
	Indicates unit connects to the PV panel.
<div style="display: flex; flex-direction: column; gap: 5px;"> <div style="background-color: black; color: white; padding: 2px;">AGM</div> <div style="background-color: black; color: white; padding: 2px;">FLD</div> <div style="background-color: black; color: white; padding: 2px;">USER</div> <div style="background-color: black; color: white; padding: 2px;">Li-ion</div> </div>	Indicates battery type.
	Indicates parallel operation is working.
	Indicates unit alarm is disabled.
	Indicates Wi-Fi transmission is working.
	Indicates USB disk is connected.

LCD Setting

General Setting

After pressing and holding "←" button for 3 seconds, the unit will enter the Setup Mode. Press "▲" or "▼" button to select setting programs. Press "←" button to confirm you selection or "↻" button to exit.

Setting Programs:



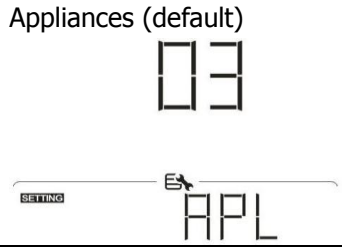
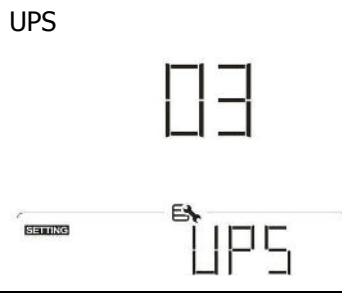
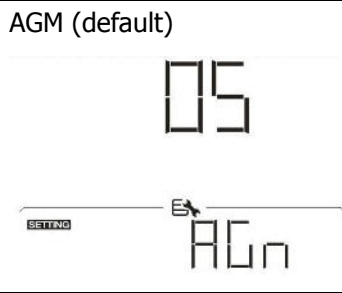
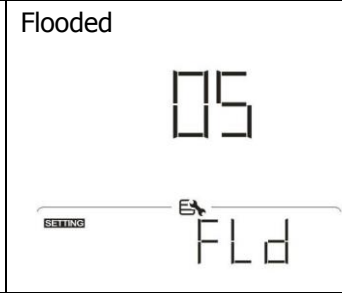
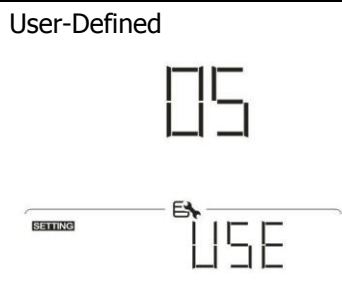
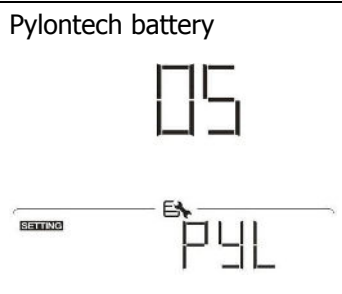
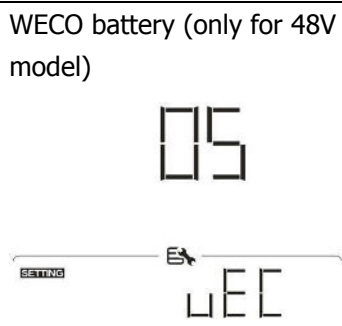



Program	Description	Selectable option	
00	Exit setting mode	Escape	
		00	
			
01	Output source priority: To configure load power source priority	Utility first (default)	Utility will provide power to the loads as first priority. Solar and battery energy will provide power to the loads only when utility power is not available.
		01	
			
		Solar first	Solar energy provides power to the loads as first priority. If solar energy is not sufficient to power all connected loads, Utility energy will supply power to the loads at the same time.
		01	
			
		SBU priority	Solar energy provides power to the loads as first priority. If solar energy is not sufficient to power all connected loads, battery energy will supply power to the loads at the same time. Utility provides power to the loads only when battery voltage drops to either low-level warning voltage or the setting point in program 12.
		01	
			
02	Maximum charging current: To configure total charging current for solar and utility chargers. (Max. charging current = utility charging current + solar charging current)	60A (default)	Setting range is from 10A to 120A. Increment of each click is 10A.
		02	
			

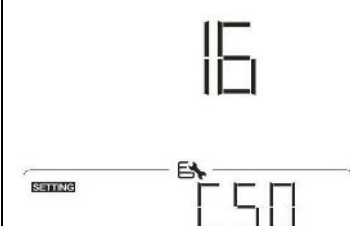
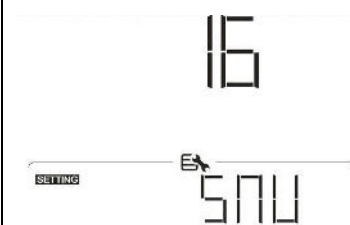
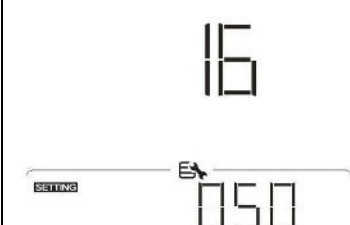
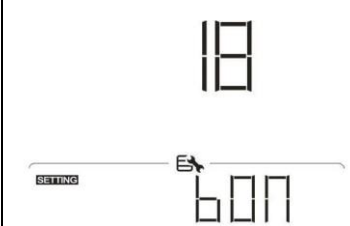
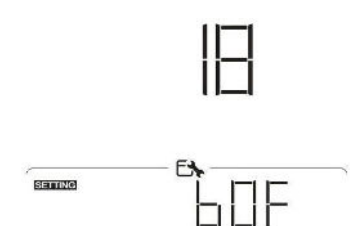
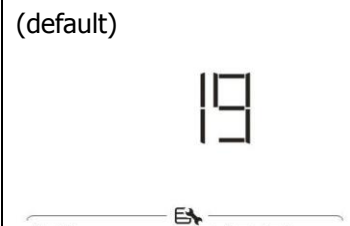
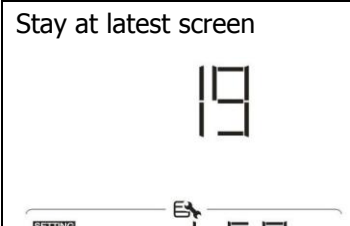

03	AC input voltage range	Appliances (default) 	If selected, acceptable AC input voltage range will be within 90-280VAC.
		UPS 	If selected, acceptable AC input voltage range will be within 170-280VAC.
05	Battery type	AGM (default) 	Flooded 
		User-Defined 	If "User-Defined" is selected, battery charge voltage and low DC cut-off voltage can be set up in program 26, 27 and 29.
		Pylontech battery 	If selected, programs of 02, 26, 27 and 29 will be automatically set up. No need for further setting.
		WECO battery (only for 48V model) 	If selected, programs of 02, 12, 26, 27 and 29 will be auto-configured per battery supplier recommended. No need for further adjustment.

05	Battery type	Soltaro battery (only for 48V model)	If selected, programs of 02, 26, 27 and 29 will be automatically set up. No need for further setting.
		LIb-protocol compatible battery	Select "LIb" if using Lithium battery compatible to Lib protocol. If selected, programs of 02, 26, 27 and 29 will be automatically set up. No need for further setting.
		3 rd party Lithium battery	If selected, programs of 02, 26, 27 and 29 will be automatically set up. No need for further setting. Please contact the battery supplier for installation procedure.
06	Auto restart when overload occurs	Restart disable (default)	Restart enable
		Restart disable (default)	Restart enable
07	Auto restart when over temperature occurs	Restart disable (default)	Restart enable
		Restart disable (default)	Restart enable
09	Output frequency	50Hz (default)	60Hz
		50Hz (default)	60Hz
10	Output voltage	220V	230V (default)
		220V	230V (default)

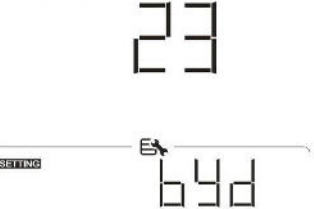
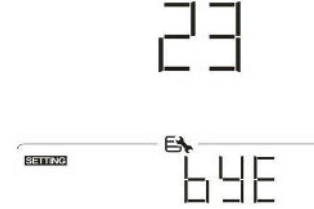
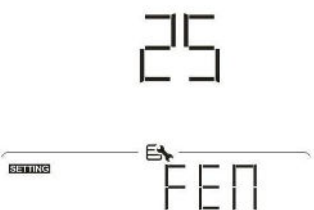
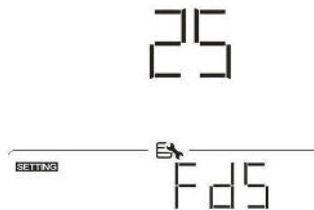
		240V 10 SETTING 240	
11	Maximum utility charging current Note: If setting value in program 02 is smaller than that in program in 11, the inverter will apply charging current from program 02 for utility charger.	30A (default) 11 SETTING 30	Setting range is 2A, then from 10A to 100A. Increment of each click is 10A.
12	Setting voltage point back to utility source when selecting "SBU" (SBU priority) in program 01.	Available options for 24V model:	
		23V (default) 12 SETTING 23	Setting range is from 22V to 25.5V. Increment of each click is 1V.
		Available options for 48V model:	
		46V (default) 12 SETTING 46	Setting range is from 44V to 51V. Increment of each click is 1V.
13	Setting voltage point back to battery mode when selecting "SBU" (SBU priority) in program 01.	Available options for 24V model: Setting range is FUL and from 24V to 29V. Increment of each click is 1V.	
		Battery fully charged 13 SETTING FUL	27V (default) 13 SETTING 27
		Available options for 48V model: Setting range is FUL and from 48V to 58V. Increment of each click is 1V.	
		Battery fully charged 13 SETTING FUL	54V (default) 13 SETTING 54

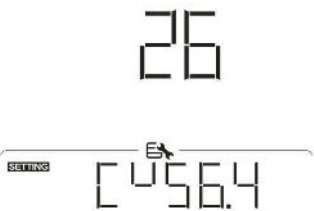

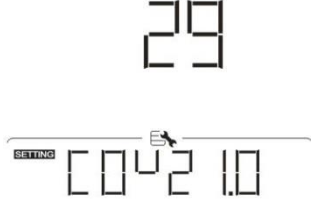
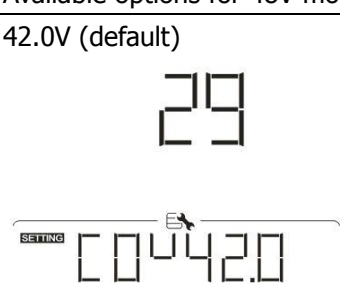
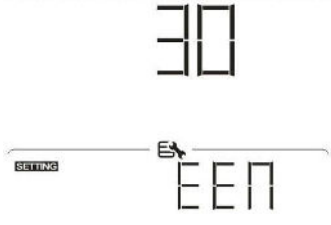
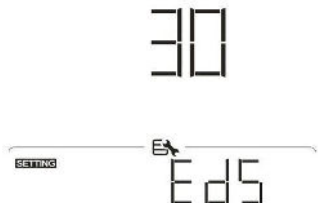

		If this inverter/charger is working in Line, Standby or Fault mode, charger source can be programmed as below:	
16	Charger source priority: To configure charger source priority	<p>Solar first</p> 	Solar energy will charge battery as first priority. Utility will charge battery only when solar energy is not available.
		<p>Solar and Utility (default)</p> 	Solar energy and utility will charge battery at the same time.
		<p>Only Solar</p> 	Solar energy will be the only charger source no matter utility is available or not.
18	Alarm control	<p>Alarm on (default)</p> 	Alarm off
			
19	Auto return to default display screen	<p>Return to default display screen (default)</p> 	If selected, no matter how users switch display screen, it will automatically return to default display screen (Input voltage /output voltage) after no button is pressed for 1 minute.
		<p>Stay at latest screen</p> 	If selected, the display screen will stay at latest screen user finally switches.

20	Backlight control	Backlight on (default) 	Backlight off 
22	Beeps while primary source is interrupted	Alarm on (default) 	Alarm off 
23	Overload bypass: When enabled, the unit will transfer to line mode if overload occurs in battery mode.	Bypass disable (default) 	Bypass enable 
25	Record Fault code	Record enable (default) 	Record disable 
26	Bulk charging voltage (C.V voltage)	Available options for 24V model:	
		28.2V (default) 	If user-defined is selected in program 5, this program can be set up. Setting range is from 25.0V to 31.5V. Increment of each click is 0.1V.
		Available options for 48V model:	
		56.4V (default) 	If user-defined is selected in program 5, this program can be set up. Setting range is from 48.0V to 61.0V. Increment of each click is 0.1V.

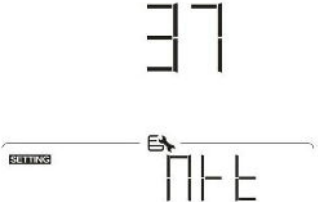
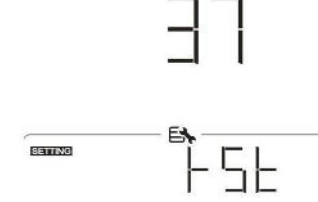
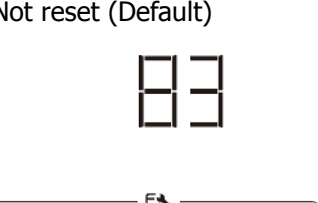
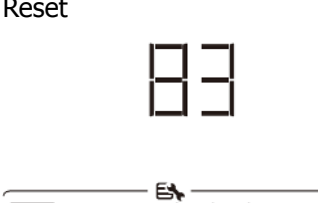
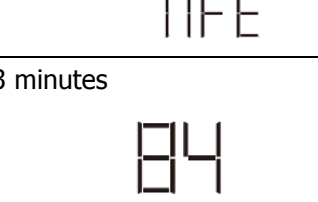
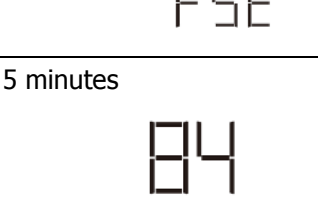
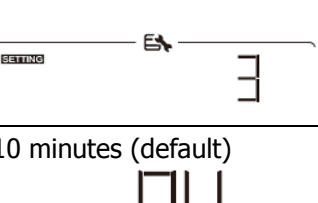
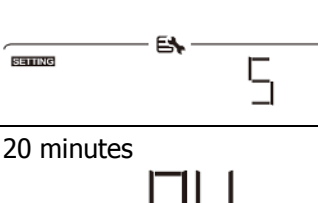
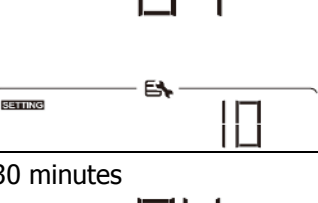
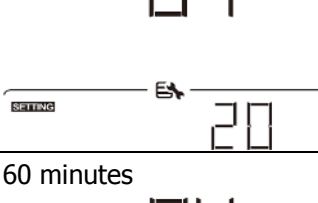
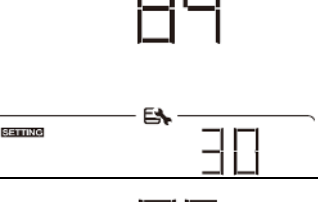
27	Floating charging voltage	Available options for 24V model:	
		27V (default) 	If user-defined is selected in program 5, this program can be set up. Setting range is from 25.0V to 31.5V. Increment of each click is 0.1V.
		Available options for 48V model:	
		54V (default) 	If user-defined is selected in program 5, this program can be set up. Setting range is from 48.0V to 61.0V. Increment of each click is 0.1V.
29	<p>Low DC cut-off voltage:</p> <ul style="list-style-type: none"> ● If battery power is only power source available, inverter will shut down. ● If PV energy and battery power are available, inverter will charge battery without AC output. <p>If PV energy, battery power and utility are all available, inverter will transfer to line mode</p>	Available options for 24V model:	
		21.0V (default) 	If user-defined is selected in program 5, this program can be set up. Setting range is from 21.0V to 24.0V. Increment of each click is 0.1V. Low DC cut-off voltage will be fixed to setting value no matter what percentage of load is connected.
		Available options for 48V model:	
		42.0V (default) 	If user-defined is selected in program 5, this program can be set up. Setting range is from 42.0V to 48.0V. Increment of each click is 0.1V. Low DC cut-off voltage will be fixed to setting value no matter what percentage of load is connected.
30	Battery equalization	Battery equalization enable 	Battery equalization disable (default) 
		If "Flooded" or "User-Defined" is selected in program 05, this program can be set up.	

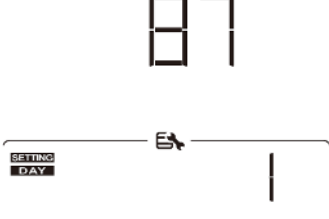
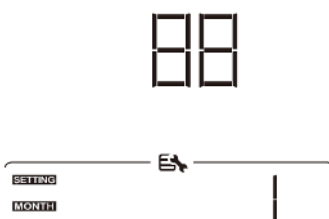
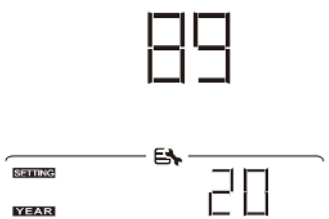
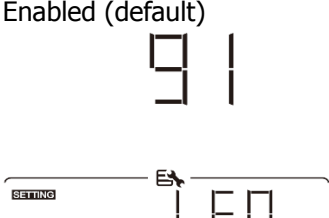
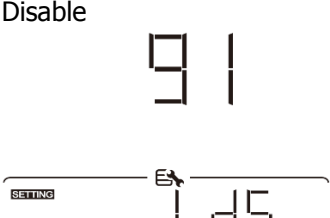
31	Battery equalization voltage	Available options for 24V model:	
		29.2V (default)	Setting range is from 25.0V to 31.5V. Increment of each click is 0.1V.
		Available options for 48V model:	
		58.4V (default)	Setting range is from 48.0V to 61.0V. Increment of each click is 0.1V.
33	Battery equalized time	60min (default)	Setting range is from 5min to 900min. Increment of each click is 5min.
34	Battery equalized timeout	120min (default)	Setting range is from 5min to 900 min. Increment of each click is 5 min.
35	Equalization interval	30days (default)	Setting range is from 0 to 90 days. Increment of each click is 1 day
36	Equalization activated immediately	Enable	Disable (default)

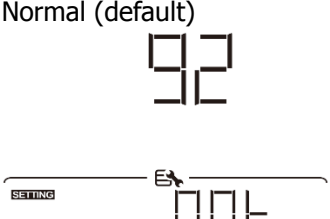



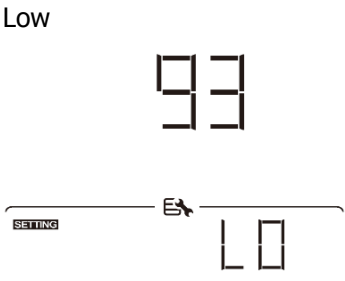
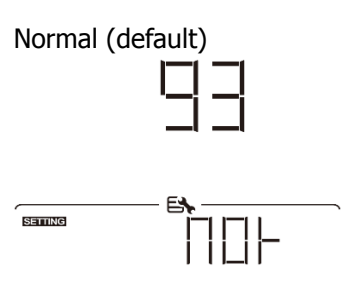
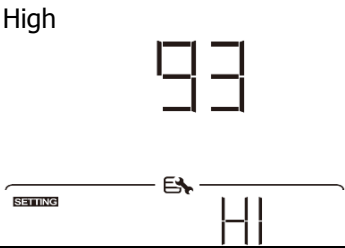
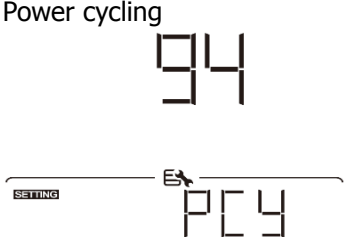
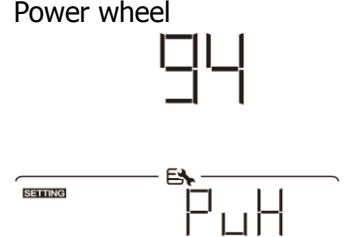
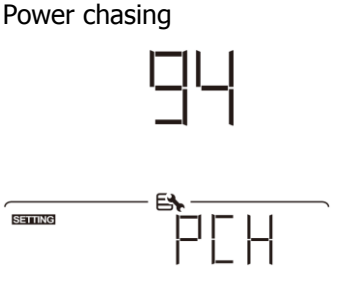
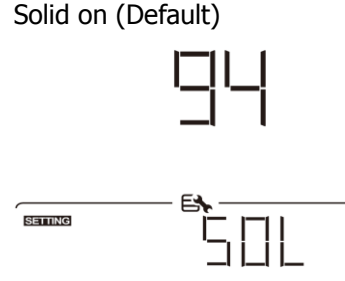
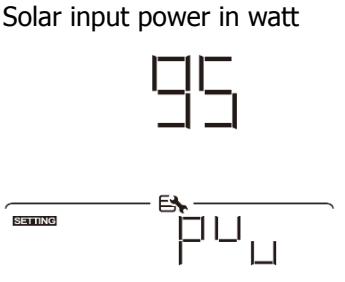

		<p>If equalization function is enabled in program 30, this program can be set up. If "Enable" is selected in this program, it's to activate battery equalization immediately and LCD main page will show "E9". If "Disable" is selected, it will cancel equalization function until next activated equalization time arrives based on program 35 setting. At this time, "E9" will not be shown in LCD main page.</p>	
37	Reset all stored data for PV generated power and output load energy	<p>Not reset(Default)</p> 	<p>Reset</p> 
83	Erase all data log	<p>Not reset (Default)</p> 	<p>Reset</p> 
84	<p>Data log recorded interval *The maximum data log number is 1440. If it's over 1440, it will re-write the first log.</p>	<p>3 minutes</p> 	<p>5 minutes</p> 
		<p>10 minutes (default)</p> 	<p>20 minutes</p> 
		<p>30 minutes</p> 	<p>60 minutes</p> 
85	Time setting – Minute		<p>For minute setting, the range is from 0 to 59.</p>

86	Time setting – Hour		For hour setting, the range is from 0 to 23.
87	Time setting– Day		For day setting, the range is from 1 to 31.
88	Time setting– Month		For month setting, the range is from 1 to 12.
89	Time setting – Year		For year setting, the range is from 17 to 99.
91	On/Off control for RGB LED *It's necessary to enable this setting to activate RGB LED lighting function.	<p>Enabled (default)</p> 	<p>Disable</p> 
92	Brightness of RGB LED	<p>Low</p> 	<p>Normal (default)</p> 
		<p>High</p> 	

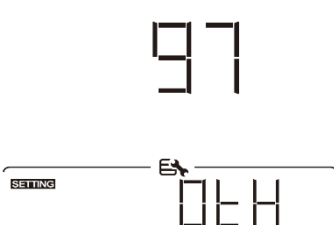
93	Lighting speed of RGB LED	Low 	Normal (default) 
		High 	
94	RGB LED effect	Power cycling 	Power wheel 
		Power chasing 	Solid on (Default) 
95	Data Presentation of data color *Energy source (Grid-PV-Battery) and battery charge/discharge status only available when RGB LED effect is set to "Solid on".	Solar input power in watt 	LED lighting portion will be changed by the percentage of solar input power and nominal PV power. If "Solid on" is selected in #94, LED ring will light up with background color setting in #96. If "Power wheel" is selected in #94, LED ring will light up in 4 levels. If "cycling" or "chasing" is selected in #94, LED ring will light up in 12 levels.

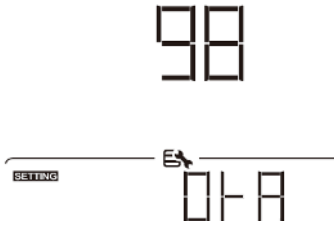
		<p>Battery capacity percentage (Default)</p> <p>95</p> <p>SETTING ← Es → bCP</p>	<p>LED lighting portion will be changed by battery capacity percentage.</p> <p>If "Solid on" is selected in #94, LED ring will light up with background color setting in #96.</p> <p>If "Power wheel" is selected in #94, LED ring will light up in 4 levels.</p> <p>If "cycling" or "chasing" is selected in #94, LED ring will light up in 12 levels.</p>
		<p>Load percentage.</p> <p>95</p> <p>SETTING ← Es → LdP</p>	<p>LED lighting portion will be changed by load percentage.</p> <p>If "Solid on" is selected in #94, LED ring will light up with background color setting in #96.</p> <p>If "Power wheel" is selected in #94, LED ring will light up in 4 levels.</p> <p>If "cycling" or "chasing" is selected in #94, LED ring will light up in 12 levels.</p>
		<p>Energy source (Grid-PV-Battery)</p> <p>95</p> <p>SETTING ← Es → EGS</p>	<p>If selected, the LED color will be background color setting in #96 in AC mode. If PV power is active, the LED color will be data color setting in #97. If the remaining status, the LED color will be set in #98.</p>
		<p>Battery charge/discharge status</p> <p>95</p> <p>SETTING ← Es → bES</p>	<p>If selected, the LED color will be background color setting in #96 in battery charging status. The LED color will be data color setting in #97 in battery discharging status.</p>
<p>96</p>	<p>Background color of RGB LED</p>	<p>Pink</p> <p>96</p> <p>SETTING ← Es → P I N</p>	<p>Orange</p> <p>96</p> <p>SETTING ← Es → O F A</p>

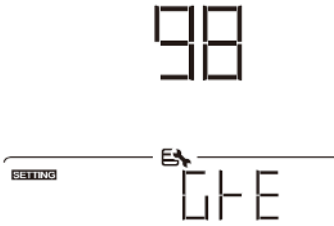
96	Background color of RGB LED	Yellow	Green
		Blue	Sky blue (Default)
		Purple	Other: If selected, the background color is set by RGB via software.
97	Data Color for RGB LED	Pink	Orange
		Yellow	Green
		Blue	Sky blue

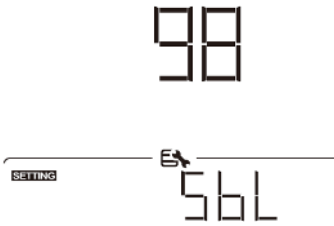
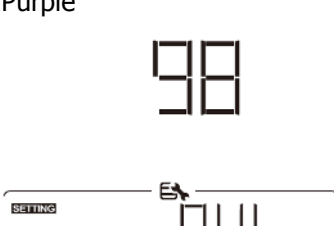
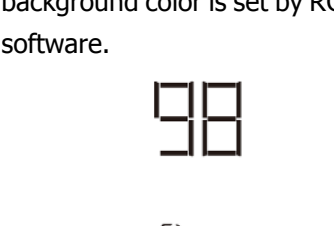
97	Data Color for RGB LED	Purple (Default) 	Other: If selected, the data color is set by RGB via software. 
98	Background color of RGB LED *Only available when data Presentation of data color is set to Energy source (Grid-PV-Battery).	Pink 	Orange 
		Yellow 	Green 
		Blue 	Sky blue (Default) 
		Purple 	Other: If selected, the background color is set by RGB via software. 

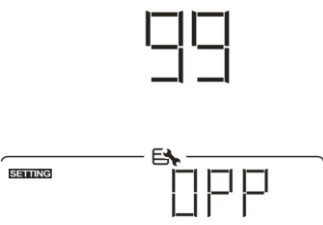
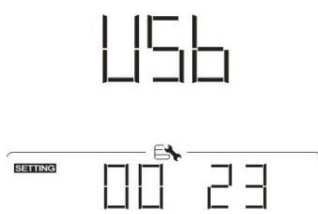
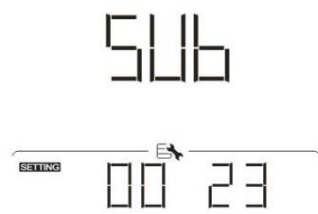
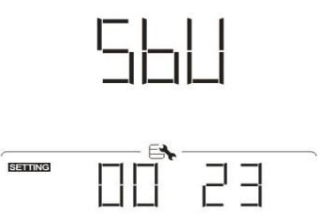
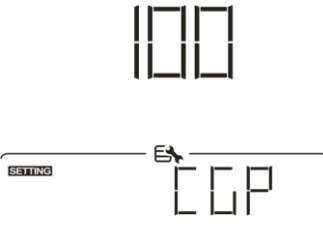
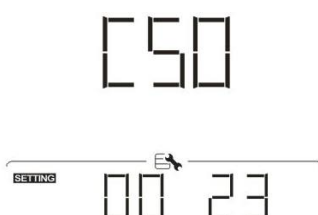
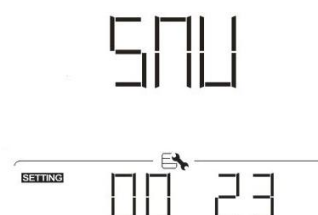
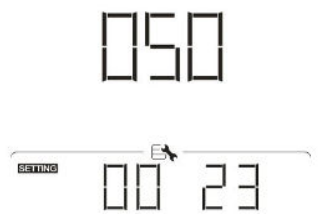
99	<p>Timer Setting for Output Source Priority</p> 	<p>Once access this program, it will show "OPP" in LCD. Press "←" button to select timer setting for output source priority. There are three timers to set up. Press "▲" or "▼" button to select specific timer option. Then, press "←" to confirm timer option. Press "▲" or "▼" button to adjust starting time first and the setting range is from 00 to 23. Increment of each click is one hour. Press "←" to confirm starting time setting. Next, the cursor will jump to right column to set up end time. Once end time is set completely, press "←" to confirm all setting.</p>	
		<p>Utility first timer</p> 	<p>Solar first timer</p> 
		<p>SBU priority timer</p> 	
100	<p>Timer Setting for Charger Source Priority</p> 	<p>Once access this program, it will show "CGP" in LCD. Press "←" button to select timer setting for charger source priority. There are three timers to set up. Press "▲" or "▼" button to select specific timer option. Then, press "←" to confirm timer option. Press "▲" or "▼" button to adjust starting time first and the setting range is from 00 to 23. Increment of each click is one hour. Press "←" to confirm starting time setting. Next, the cursor will jump to right column to set up end time. Once end time is set completely, press "←" to confirm all setting.</p>	
		<p>Solar first</p> 	<p>Solar and utility</p> 
		<p>Only solar</p> 	

USB Function Setting

There are three USB function setting such as firmware upgrade, data log export and internal parameter re-write from the USB disk. Please follow below procedure to execute selected USB function setting.

Procedure	LCD Screen
Step 1: Insert an OTG USB disk into the USB port (L).	
Step 2: Press "↻" button to enter USB function setting.	

Step 3: Please select setting program by following the procedure.

Program#	Operation Procedure	LCD Screen
Upgrade firmware	After entering USB function setting, press "←" button to enter "upgrade firmware" function. This function is to upgrade inverter firmware. If firmware upgrade is needed, please check with your dealer or installer for detail instructions.	
Re-write internal parameters	After entering USB function setting, press "▼" button to switch to "Re-write internal parameters" function. This function is to overwrite all parameter settings (TEXT file) with settings in the USB disk from a previous setup or to duplicate inverter settings. Please check with your dealer or installer for detail instructions.	
Export data log	After entering USB function setting, press "▼" button twice to switch to "export data log" function and it will show "LOG" in the LCD. Press "←" button to confirm the selection for export data log.	
	<p>If the selected function is ready, LCD will display "fdy". Press "←" button to confirm the selection again.</p> <ul style="list-style-type: none"> ● Press "▲" button to select "Yes" to export data log. "YES" will disappear after this action is complete. Then, press "↻" button to return to main screen. ● Or press "▼" button to select "No" to return to main screen. 	

If no button is pressed for 1 minute, it will automatically return to main screen.

Error message:



Error Code	Messages
U01	No USB disk is detected.
U02	USB disk is protected from copy.
U03	Document inside the USB disk with wrong format.

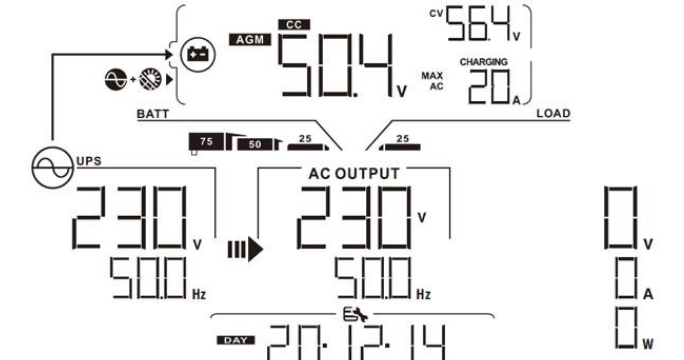
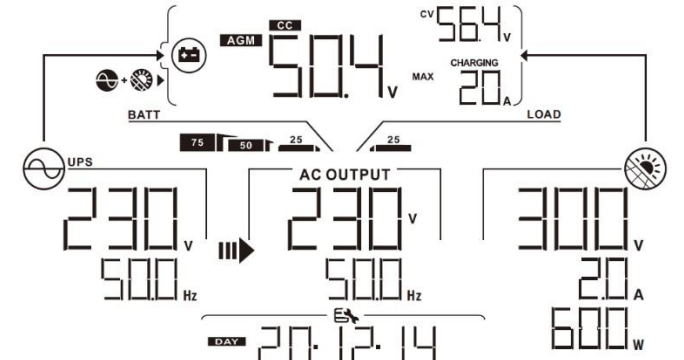
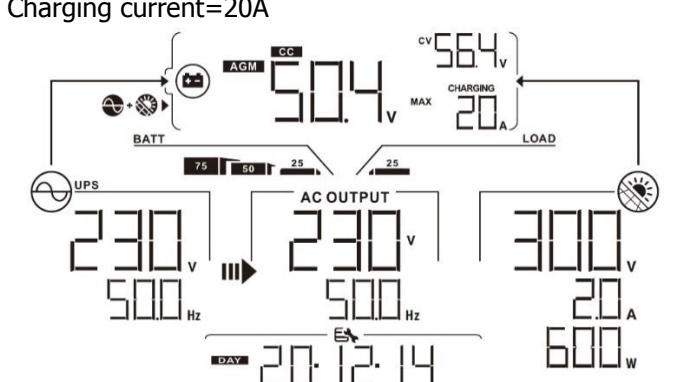
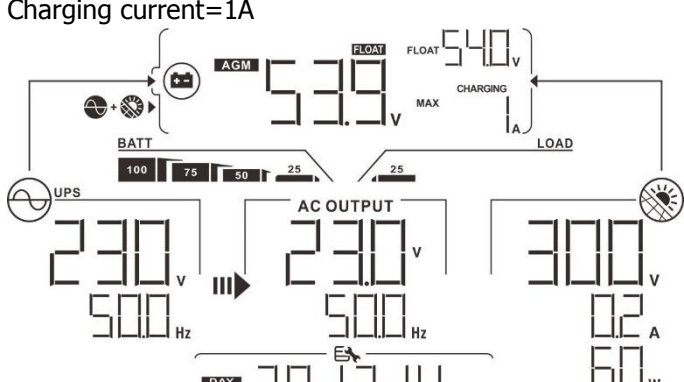

If any error occurs, error code will only show 3 seconds. After 3 seconds, it will automatically return to display screen.

LCD Display

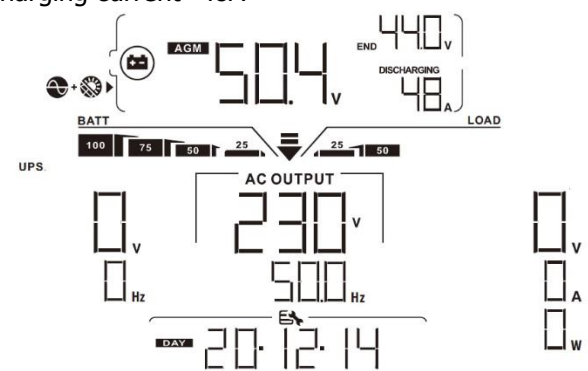
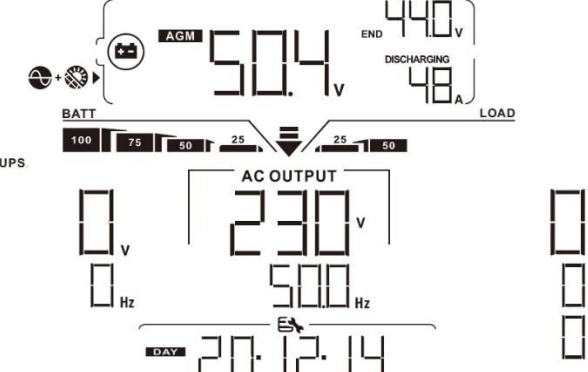

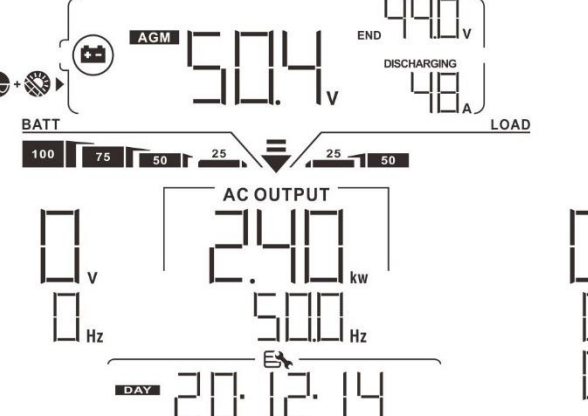
The LCD display information will be switched in turn by pressing the "▲" or "▼" button. The selectable information is switched as the following table in order.

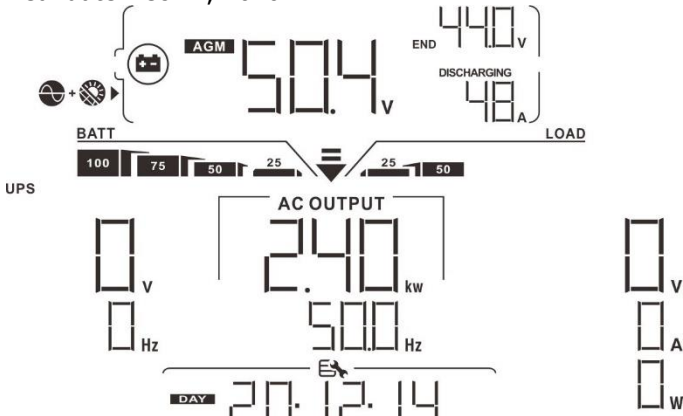
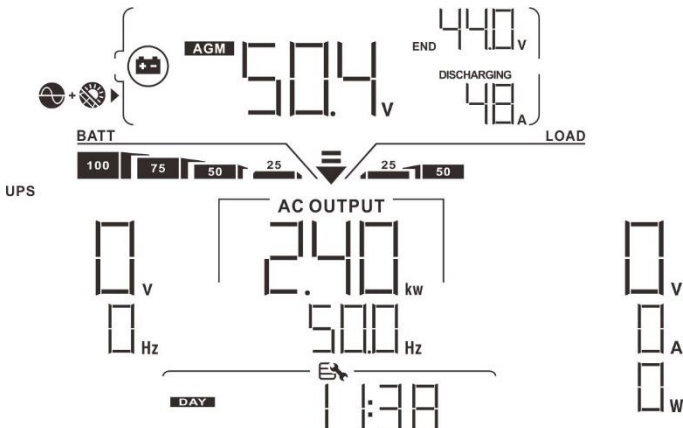
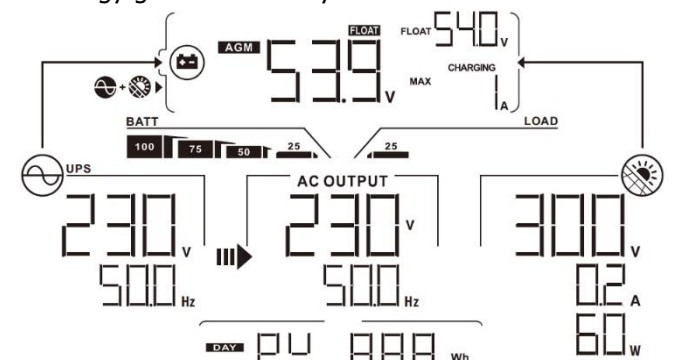
	Selectable information	LCD display
Default Display Screen	Utility voltage/ Utility frequency	<p>Input Voltage=230V, Input frequency=50Hz</p> 
	PV voltage/ PV current/ PV power	<p>PV voltage=300V, PV current=2.0A, PV power=600W</p> 
	Battery voltage, charging stage/ Configured battery parameters/ Charging or discharging current	<p>Battery voltage=50.4V, Bulk charging voltage=56.4V, Charging current=20A</p> 
	Battery voltage=53.9V, Floating charging voltage=54.0V, Charging current=1A	<p>Battery voltage=53.9V, Floating charging voltage=54.0V, Charging current=1A</p> 

	<p>Battery voltage, charging stage/ Configured battery parameters/ Charging or discharging current</p>	<p>Battery voltage=50.4V, Low DC cut-off voltage=44.0V, Discharging current=48A</p> 
<p>Default Display Screen</p>		<p>Output voltage=230V, Output frequency=50Hz</p> 
	<p>Output voltage, load in VA, load in Watt switch every 5 second/ Output frequency</p>	<p>Load in VA=2.4kVA, Output frequency=50Hz</p> 
		<p>Load in Watt=2.4kW, Output frequency=50Hz</p> 

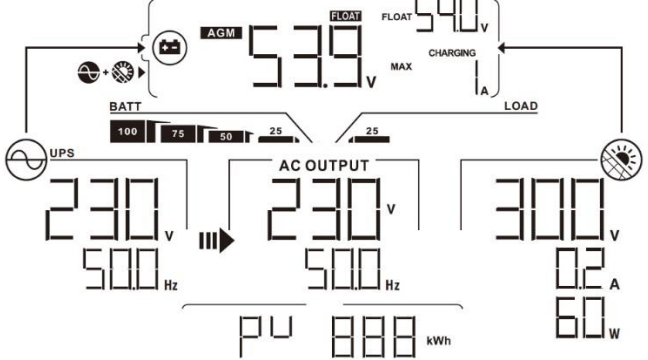
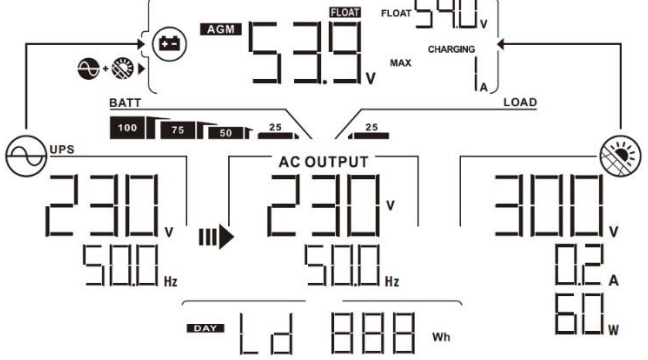
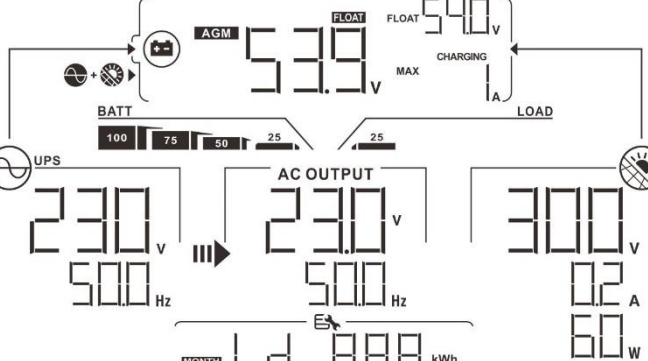
<p>Default Display Screen</p>	<p>Real date</p>	<p>Real date Dec 14, 2020.</p> 
<p>Real time</p>	<p>Real time</p>	<p>Real time 11:38.</p> 
<p>PV energy generation today</p>	<p>PV energy generation today</p>	<p>PV energy generation today = 888Wh.</p> 
<p>PV energy generation this month</p>	<p>PV energy generation this month</p>	<p>PV energy generation this month = 8.88kWh.</p> 

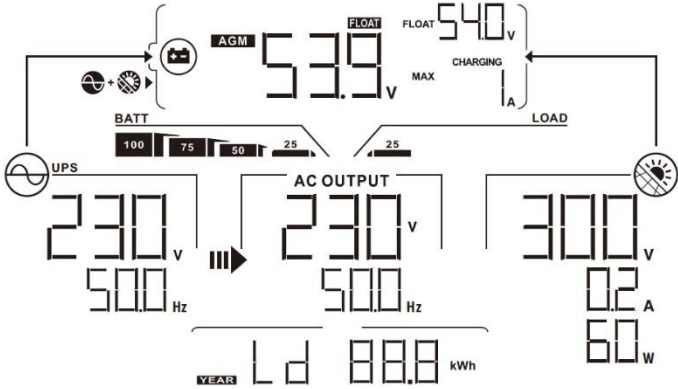
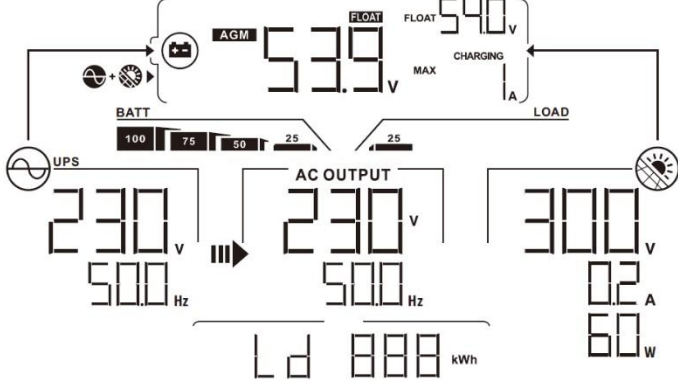
<p>PV energy generation this year</p>	<p>PV energy generation this year =88.8kWh.</p> 
<p>Total PV energy generation</p>	<p>Total PV energy generation =888kWh.</p> 
<p>Load output energy today</p>	<p>Load output energy today =888Wh.</p> 
<p>Load output energy this month</p>	<p>Load output energy this month =8.88kWh.</p> 

<p>Load output energy this year</p>	<p>Load output energy this year =88.8kWh.</p> 
<p>Total load output energy</p>	<p>Total load output energy=888kWh.</p> 
<p>Main CPU version checking</p>	<p>Main CPU version 00050.72.</p> 
<p>Secondary CPU version checking</p>	<p>Secondary CPU version 00022.01.</p> 

<p>Wi-Fi version checking</p>	<p>Wi-Fi version 00088.88.</p> 
-------------------------------	---

Operating Mode Description

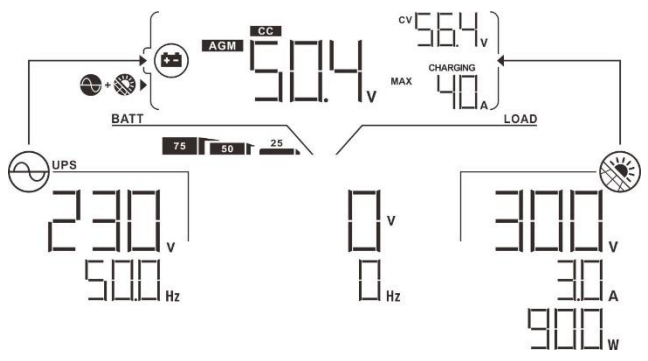
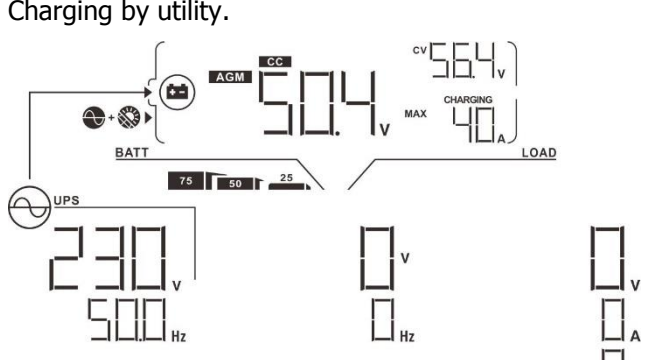
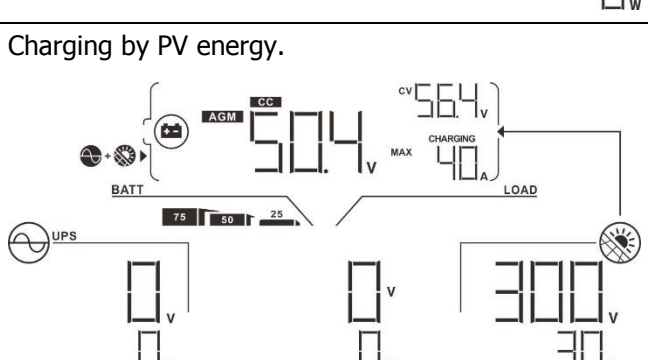
Operation mode	Description	LCD display
<p>Standby mode</p> <p>Note: *Standby mode: The inverter is not turned on yet but at this time, the inverter can charge battery without AC output.</p>	<p>No output is supplied by the unit but it still can charge batteries.</p>	<p>Charging by utility and PV energy.</p>  <p>Charging by utility.</p>  <p>Charging by PV energy.</p> 

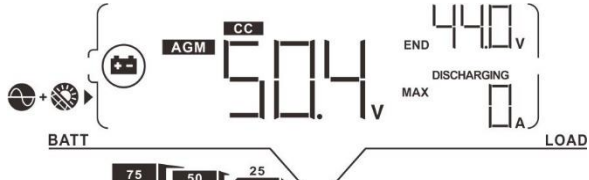
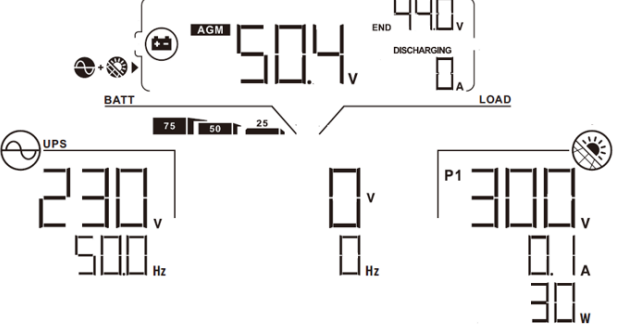
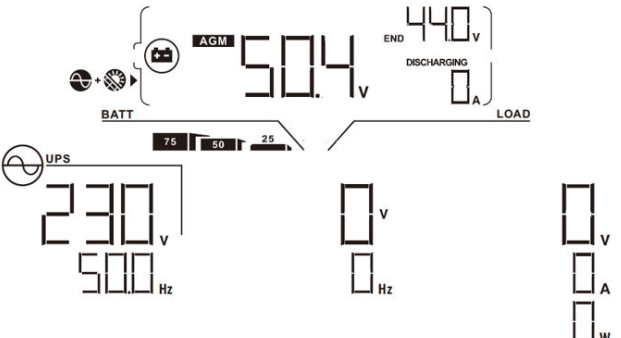
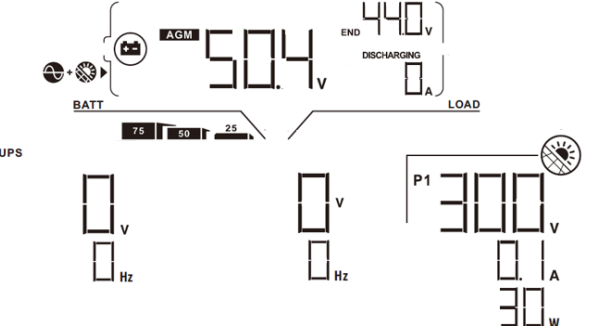
Operation mode	Description	LCD display
Standby mode	No output is supplied by the unit but it still can charge batteries.	<p>No charging.</p> 
<p>Fault mode</p> <p>Note:</p> <p>*Fault mode: Errors are caused by inside circuit error or external reasons such as over temperature, output short circuited and so on.</p>	<p>No charging at all no matter if grid or PV power is available.</p>	<p>Grid and PV power are available.</p> 
		<p>Grid is available.</p> 
		<p>PV power is available.</p> 

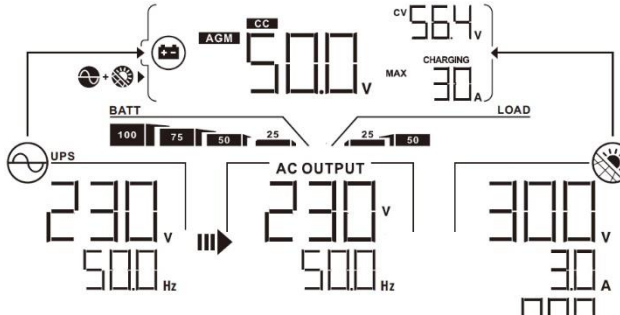
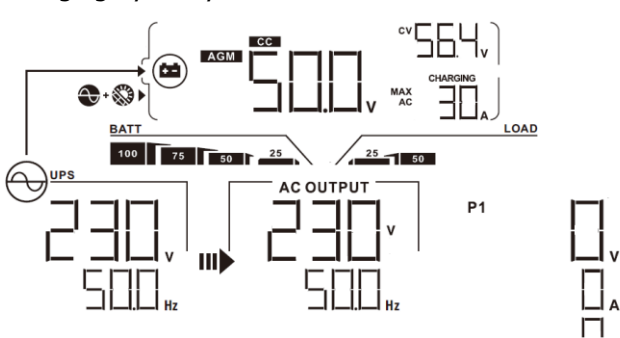
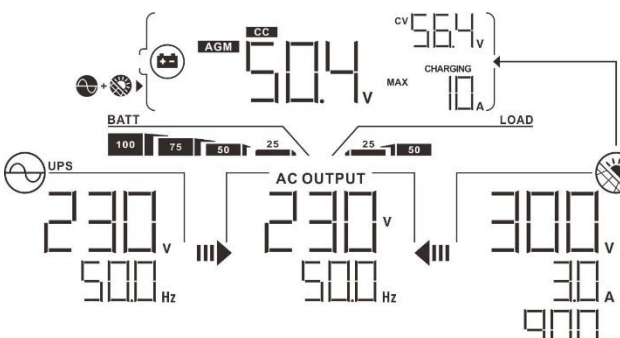
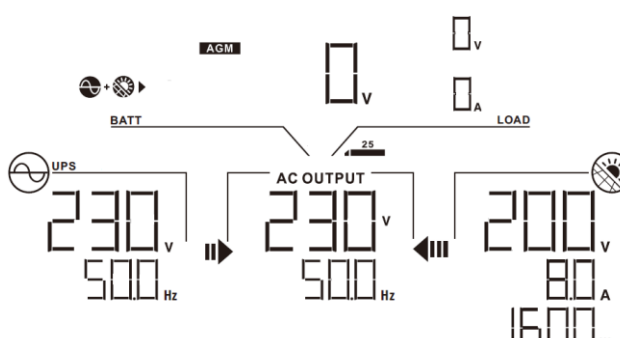
Operation mode	Description	LCD display
Line Mode		<p>Charging by utility and PV energy.</p> 
		<p>Charging by utility.</p> 
	The unit will provide output power from the mains. It will also charge the battery at line mode.	<p>If "SUB" (solar first) is selected as output source priority and solar energy is not sufficient to provide the load, solar energy and the utility will provide the loads and charge the battery at the same time.</p> 
		<p>If either "SUB" (solar first) or "SBU" is selected as output source priority and battery is not connected, solar energy and the utility will provide the loads.</p> 

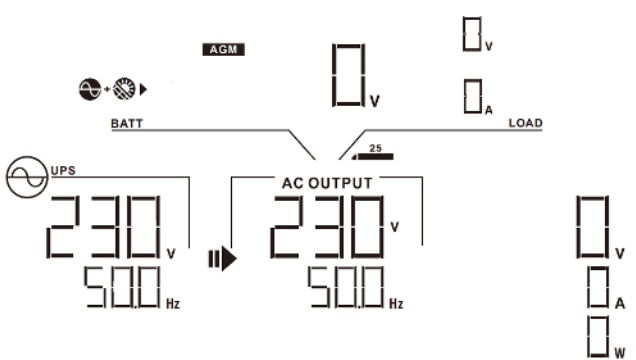
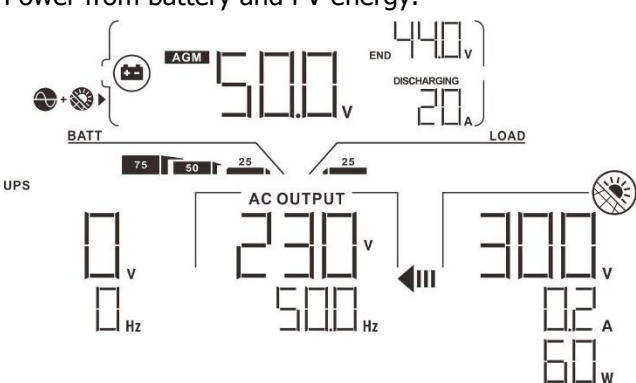
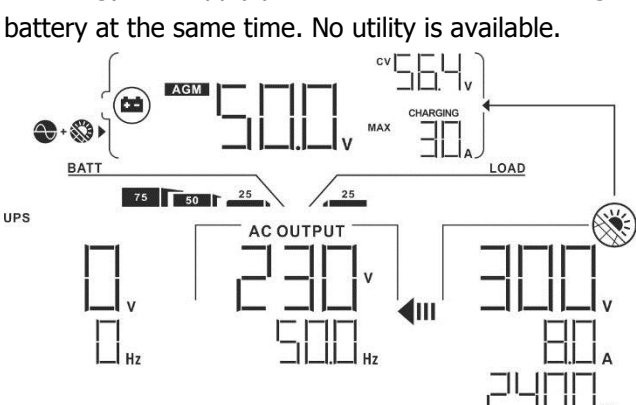
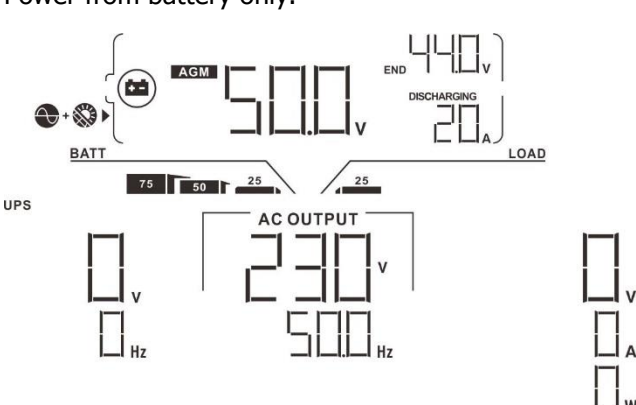









Operation mode	Description	LCD display
Line Mode	The unit will provide output power from the mains. It will also charge the battery at line mode.	<p>Power from utility</p> 
Battery Mode	The unit will provide output power from battery and/or PV power.	<p>Power from battery and PV energy.</p> 
		<p>PV energy will supply power to the loads and charge battery at the same time. No utility is available.</p> 
		<p>Power from battery only.</p> 

Operation mode	Description	LCD display
Battery Mode	The unit will provide output power from battery and/or PV power.	<p>Power from PV energy only.</p>

Faults Reference Code

Fault Code	Fault Event	Icon on
01	Fan is locked when inverter is off.	F01
02	Over temperature	F02
03	Battery voltage is too high	F03
04	Battery voltage is too low	F04
05	Output short circuited.	F05
06	Output voltage is too high.	F06
07	Overload time out	F07
08	Bus voltage is too high	F08
09	Bus soft start failed	F09
10	PV over current	F10
11	PV over voltage	F11
12	DCDC over current	F12
13	Battery discharge over current	F13
51	Over current	F51
52	Bus voltage is too low	F52
53	Inverter soft start failed	F53
55	Over DC voltage in AC output	F55
57	Current sensor failed	F57
58	Output voltage is too low	F58

Warning Indicator

Warning Code	Warning Event	Audible Alarm	Icon flashing
01	Fan is locked when inverter is on.	Beep three times every second	01 
02	Over temperature	None	02 
03	Battery is over-charged	Beep once every second	03 
04	Low battery	Beep once every second	04 
07	Overload	Beep once every 0.5 second	07  
10	Output power derating	Beep twice every 3 seconds	10 
15	PV energy is low.	Beep twice every 3 seconds	15 
16	High AC input (>280VAC) during BUS soft start	None	16 
32	Communication failure between inverter and display panel	None	32 
E9	Battery equalization	None	E9 

CLEARANCE AND MAINTENANCE FOR ANTI-DUST KIT

Overview

Every inverter is already installed with anti-dusk kit from factory. This kit also keeps dusk from your inverter and increases product reliability in harsh environment.

Clearance and Maintenance

Step 1: Please remove the screws on the sides of the inverter.

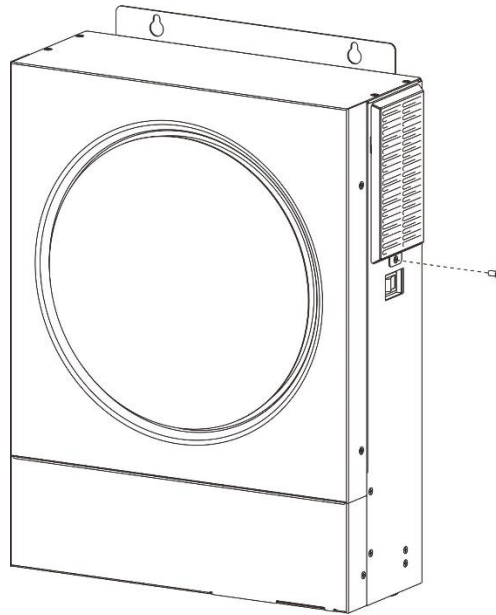

Step 2: Then, dustproof case can be removed and take out air filter foam as shown in below chart.

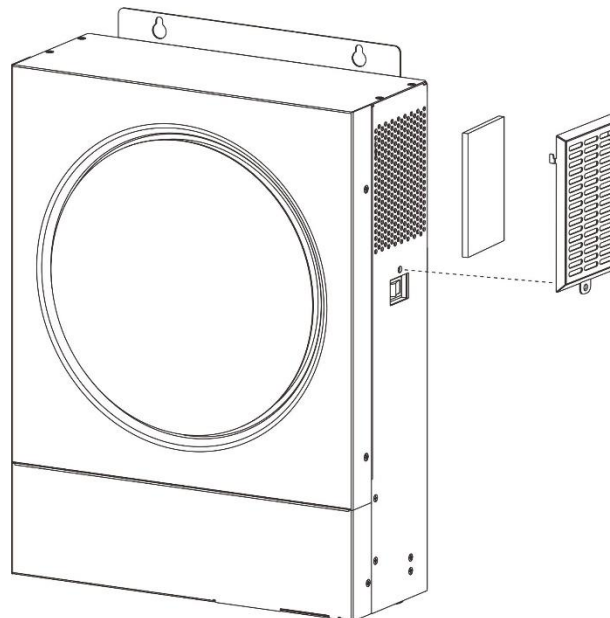

Step 3: Clean air filter foam and dustproof case. After clearance, re-assemble the dust-kit back to the inverter.

NOTICE: The anti-dust kit should be cleaned from dust every one month.

BATTERY EQUALIZATION

Equalization function is added into charge controller. It reverses the buildup of negative chemical effects like stratification, a condition where acid concentration is greater at the bottom of the battery than at the top. Equalization also helps to remove sulfate crystals that might have built up on the plates. If left unchecked, this condition, called sulfation, will reduce the overall capacity of the battery. Therefore, it's recommended to equalize battery periodically.

- **How to Apply Equalization Function**

You must enable battery equalization function in monitoring LCD setting program 33 first. Then, you may apply this function in device by either one of following methods:

1. Setting equalization interval in program 37.
2. Active equalization immediately in program 39.

- **When to Equalize**

In float stage, when the setting equalization interval (battery equalization cycle) is arrived, or equalization is active immediately, the controller will start to enter Equalize stage.

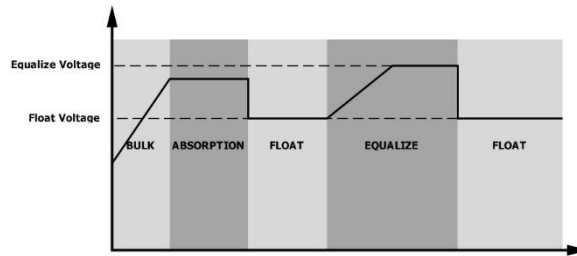

- **Equalize charging time and timeout**

In Equalize stage, the controller will supply power to charge battery as much as possible until battery voltage raises to battery equalization voltage. Then, constant-voltage regulation is applied to maintain battery voltage at the battery equalization voltage. The battery will remain in the Equalize stage until setting battery equalized time is arrived.

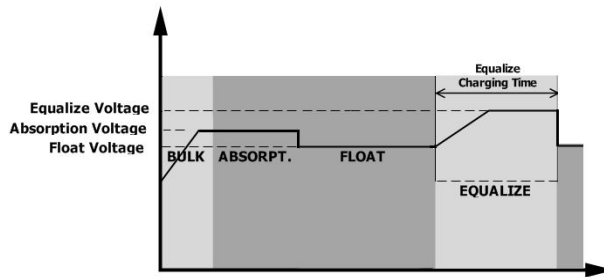

However, in Equalize stage, when battery equalized time is expired and battery voltage doesn't rise to battery equalization voltage point, the charge controller will extend the battery equalized time until battery voltage achieves battery equalization voltage. If battery voltage is still lower than battery equalization voltage when battery equalized timeout setting is over, the charge controller will stop equalization and return to float stage.

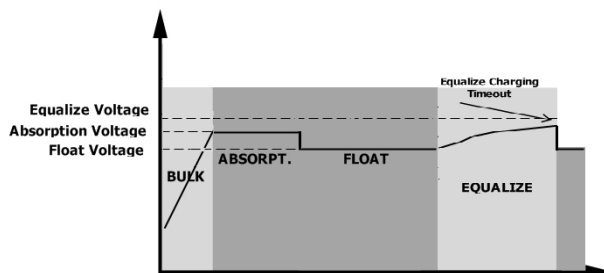

SPECIFICATIONS

Table 1 Line Mode Specifications

MODEL	Direct Solar 3.6KW	Direct Solar 5.6KW
Input Voltage Waveform	Sinusoidal (utility or generator)	
Nominal Input Voltage	230Vac	
Low Loss Voltage	170Vac±7V (UPS); 90Vac±7V (Appliances)	
Low Loss Return Voltage	180Vac±7V (UPS); 100Vac±7V (Appliances)	
High Loss Voltage	280Vac±7V	
High Loss Return Voltage	270Vac±7V	
Max AC Input Voltage	300Vac	
Nominal Input Frequency	50Hz / 60Hz (Auto detection)	
Low Loss Frequency	40±1Hz	
Low Loss Return Frequency	42±1Hz	
High Loss Frequency	65±1Hz	
High Loss Return Frequency	63±1Hz	
Output Short Circuit Protection	Circuit Breaker	
Efficiency (Line Mode)	>95% (Rated R load, battery full charged)	
Transfer Time	10ms typical (UPS); 20ms typical (Appliances)	
<p>Output power derating: When AC input voltage drops to 170V, the output power will be derated.</p>	<p>The graph plots Output Power on the vertical axis against Input Voltage on the horizontal axis. The horizontal axis has markers at 90V, 170V, and 280V. The vertical axis has markers for 50% Power and Rated Power. The power is zero until 90V, then jumps to 50% power. From 90V to 170V, the power increases linearly to reach Rated Power. From 170V to 280V, the power remains constant at the Rated Power level. After 280V, the power drops to zero.</p>	

Table 2 Inverter Mode Specifications

MODEL	Direct Solar 3.6KW	Direct Solar 5.6KW
Rated Output Power	3.6KVA/3.6KW	5.6KVA/5.6KW
Output Voltage Waveform	Pure Sine Wave	
Output Voltage Regulation	230Vac±5%	
Output Frequency	50Hz	
Peak Efficiency	93%	
Overload Protection	5s@≥130% load; 10s@105%~130% load	
Surge Capacity	2* rated power for 5 seconds	
Nominal DC Input Voltage	24Vdc	48Vdc
Cold Start Voltage	23.0Vdc	46.0Vdc
Low DC Warning Voltage		
@ load < 50%	23.0Vdc	46.0Vdc
@ load ≥ 50%	22.0Vdc	44.0Vdc
Low DC Warning Return Voltage		
@ load < 50%	23.5Vdc	47.0Vdc
@ load ≥ 50%	23.0Vdc	46.0Vdc
Low DC Cut-off Voltage		
@ load < 50%	21.5Vdc	43.0Vdc
@ load ≥ 50%	21.0Vdc	42.0Vdc
High DC Recovery Voltage	32Vdc	62Vdc
High DC Cut-off Voltage	33Vdc	63Vdc
No Load Power Consumption	<40W	<55W

Table 3 Charge Mode Specifications

Utility Charging Mode			
MODEL	Direct Solar 3.6KW	Direct Solar 5.6KW	
Charging Current (UPS) @ Nominal Input Voltage	100Amp(@V _{I/P} =230Vac)		
Bulk Charging Voltage	Flooded Battery	29.2	58.4Vdc
	AGM / Gel Battery	28.2	56.4Vdc
Floating Charging Voltage	27Vdc	54Vdc	
Charging Algorithm	3-Step		
Charging Curve			
Solar Input			
MODEL	Direct Solar 3.6KW	Direct Solar 5.6KW	
Max. PV Array Power	4000W	6000W	
Nominal PV Voltage	240Vdc	360Vdc	
Start-up Voltage	150Vdc +/- 10Vdc		
PV Array MPPT Voltage Range	120~450Vdc		
Max. PV Array Open Circuit Voltage	500Vdc		
Max Charging Current (AC charger plus solar charger)	120Amp		

Table 4 General Specifications

MODEL	Direct Solar 3.6KW	Direct Solar 5.6KW
Operating Temperature Range	-10°C to 50°C	
Storage temperature	-15°C~ 60°C	
Humidity	5% to 95% Relative Humidity (Non-condensing)	
Dimension (D*W*H), mm	119 x 313.6 x 422.8	
Net Weight, kg	10	12

TROUBLE SHOOTING

Problem	LCD/LED/Buzzer	Explanation / Possible cause	What to do
Unit shuts down automatically during startup process.	LCD/LEDs and buzzer will be active for 3 seconds and then complete off.	The battery voltage is too low (<1.91V/Cell)	1. Re-charge battery. 2. Replace battery.
No response after power on.	No indication.	1. The battery voltage is far too low. (<1.4V/Cell) 2. Battery polarity is connected reversed.	1. Check if batteries and the wiring are connected well. 2. Re-charge battery. 3. Replace battery.
Mains exist but the unit works in battery mode.	Input voltage is displayed as 0 on the LCD and green LED is flashing.	Input protector is tripped	Check if AC breaker is tripped and AC wiring is connected well.
	Green LED is flashing.	Insufficient quality of AC power. (Shore or Generator)	1. Check if AC wires are too thin and/or too long. 2. Check if generator (if applied) is working well or if input voltage range setting is correct. (UPS→Appliance)
	Green LED is flashing.	Set "Solar First" as the priority of output source.	Change output source priority to Utility first.
When the unit is turned on, internal relay is switched on and off repeatedly.	LCD display and LEDs are flashing	Battery is disconnected.	Check if battery wires are connected well.
Buzzer beeps continuously and red LED is on.	Fault code 07	Overload error. The inverter is overload 110% and time is up.	Reduce the connected load by switching off some equipment.
	Fault code 05	Output short circuited.	Check if wiring is connected well and remove abnormal load.
	Fault code 02	Internal temperature of inverter component is over 100°C.	Check whether the air flow of the unit is blocked or whether the ambient temperature is too high.
	Fault code 03	Battery is over-charged.	Return to repair center.
		The battery voltage is too high.	Check if spec and quantity of batteries are meet requirements.
	Fault code 01	Fan fault	Replace the fan.
	Fault code 06/58	Output abnormal (Inverter voltage below than 190Vac or is higher than 260Vac)	1. Reduce the connected load. 2. Return to repair center
	Fault code 08/09/53/57	Internal components failed.	Return to repair center.
	Fault code 51	Over current or surge.	Restart the unit, if the error happens again, please return to repair center.
	Fault code 52	Bus voltage is too low.	
Fault code 55	Output voltage is unbalanced.		
Fault code 56	Battery is not connected well or fuse is burnt.	If the battery is connected well, please return to repair center.	

Appendix I: BMS Communication Installation

1. Introduction

If connecting to lithium battery, it is recommended to purchase a custom-made RJ45 communication cable. Please check with your dealer or integrator for details.

This custom-made RJ45 communication cable delivers information and signal between lithium battery and the inverter. These information are listed below:

- Re-configure charging voltage, charging current and battery discharge cut-off voltage according to the lithium battery parameters.
- Have the inverter start or stop charging according to the status of lithium battery.

2. Pin Assignment for BMS Communication Port

	Definition
PIN 1	RS232TX
PIN 2	RS232RX
PIN 3	RS485B
PIN 4	NC
PIN 5	RS485A
PIN 6	CANH
PIN 7	CANL
PIN 8	GND

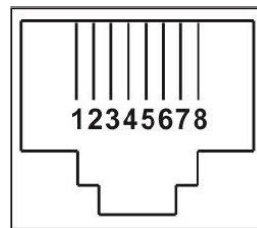

3. Lithium Battery Communication Configuration

LIO-4805/LIO-4810-150A

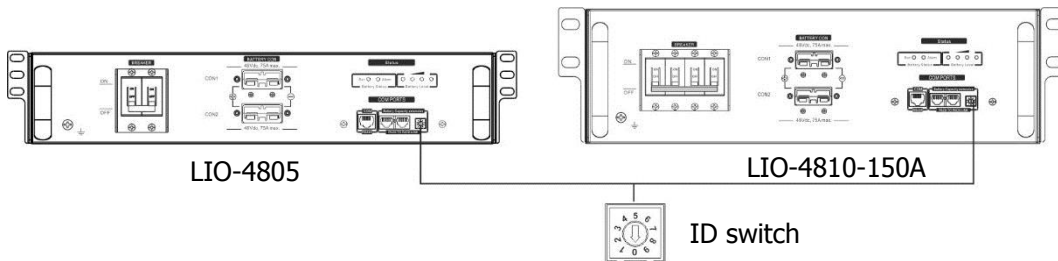

ESS LIO-I 4810

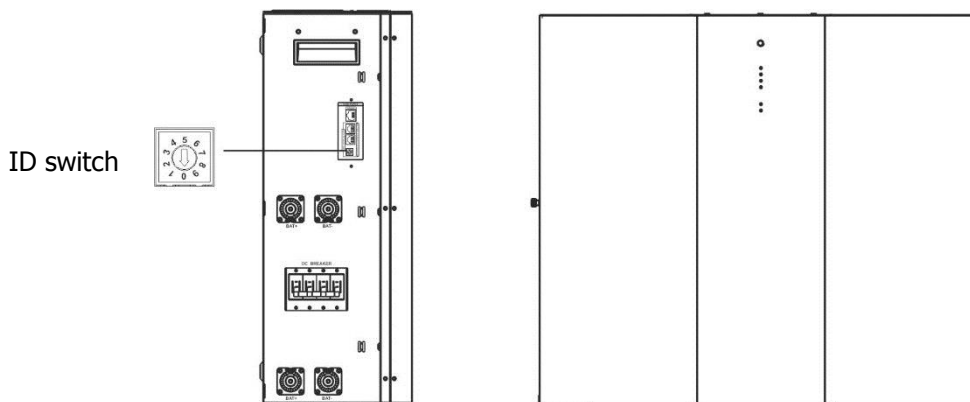

ID Switch indicates the unique ID code for each battery module. It's required to assign a unique ID to each battery module for normal operation. We can set up the ID code for each battery module by rotating the PIN number on the ID switch. From number 0 to 9, the number can be random; no particular order. Maximum 10 battery modules can be operated in parallel.

PYLONTECH

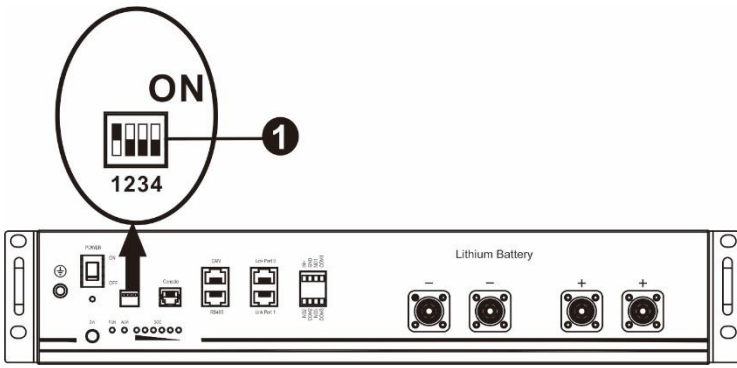

①Dip Switch: There are 4 Dip Switches that sets different baud rate and battery group address. If switch position is turned to the "OFF" position, it means "0". If switch position is turned to the "ON" position, it means "1".

Dip 1 is "ON" to represent the baud rate 9600.

Dip 2, 3 and 4 are reserved for battery group address.

Dip switch 2, 3 and 4 on master battery (first battery) are to set up or change the group address.

NOTE: "1" is upper position and "0" is bottom position.

Dip 1	Dip 2	Dip 3	Dip 4	Group address
1: RS485 baud rate=9600 Restart to take effect	0	0	0	Single group only. It's required to set up master battery with this setting and slave batteries are unrestricted.
	1	0	0	Multiple group condition. It's required to set up master battery on the first group with this setting and slave batteries are unrestricted.
	0	1	0	Multiple group condition. It's required to set up master battery on the second group with this setting and slave batteries are unrestricted.
	1	1	0	Multiple group condition. It's required to set up master battery on the third group with this setting and slave batteries are unrestricted.
	0	0	1	Multiple group condition. It's required to set up master battery on the fourth group with this setting and slave batteries are unrestricted.
	1	0	1	Multiple group condition. It's required to set up master battery on the fifth group with this setting and slave batteries are unrestricted.

NOTE: The maximum groups of lithium battery is 5 and for maximum number for each group, please check with battery manufacturer.

4. Installation and Operation

LIO-4805/LIO-4810-150A/ESS LIO-I 4810

After ID no. is assigned for each battery module, please set up LCD panel in inverter and install the wiring connection as following steps.

Step 1: Use supplied RJ11 signal cable to connect into the extension port (P1 or P2).

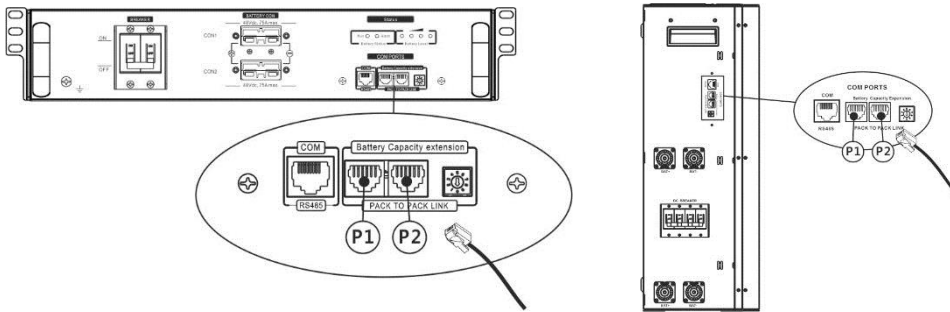

Step 2: Use supplied RJ45 cable (from battery module package) to connect inverter and Lithium battery.

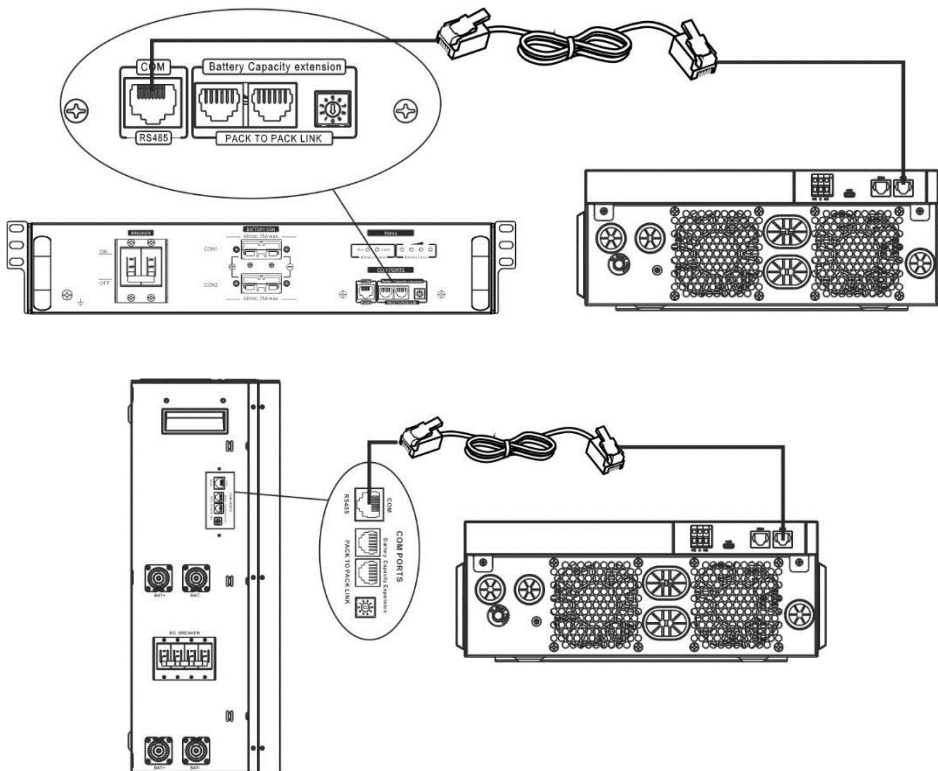

*** For multiple battery connection, please check battery manual for the details.**

Note for parallel system:

1. Only support common battery installation.
2. Use custom-made RJ45 cable to connect any inverter (no need to connect to a specific inverter) and Lithium battery. Simply set this inverter battery type to "LIB" in LCD program 5. Others should be "USE".

Step 3: Turn the breaker switch "ON". Now, the battery module is ready for DC output.

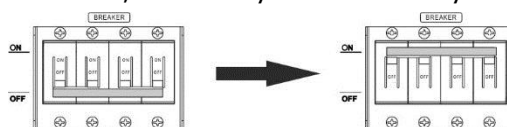

Step 4: Press Power on/off button on battery module for 5 secs, the battery module will start up.

*If the manual button cannot be approached, just simply turn on the inverter module. The battery module will be automatically turned on.

Step 5. Turn on the inverter.

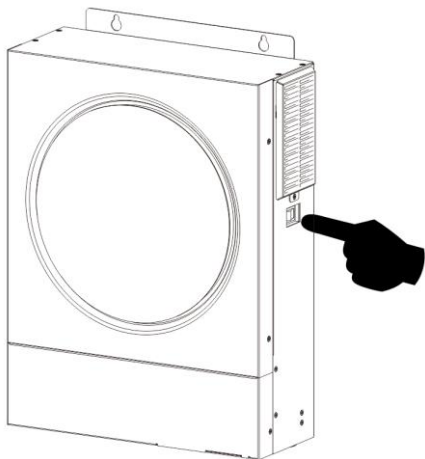

Step 6. Be sure to select battery type as "LIB" in LCD program 5.



If communication between the inverter and battery is successful, the battery icon  on LCD display will flash. Generally speaking, it will take longer than 1 minute to establish communication.

PYLONTECH

Step 1. Use custom-made RJ45 cable to connect inverter and Lithium battery.

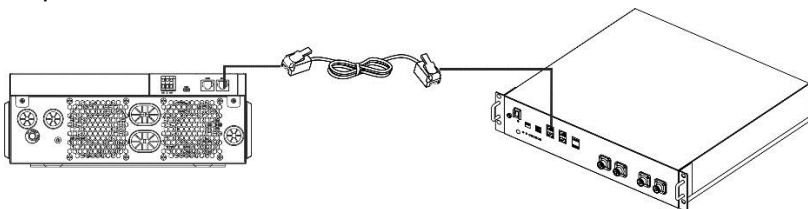

Step 2. Switch on Lithium battery.

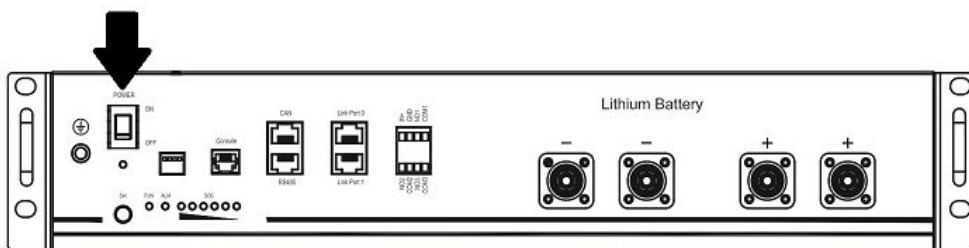

Step 3. Press more than three seconds to start Lithium battery, power output ready.

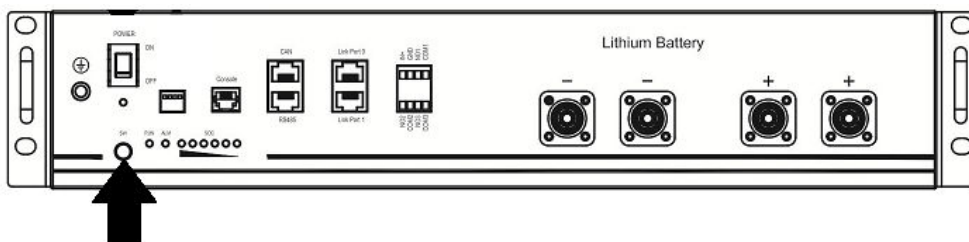

Step 4. Turn on the inverter.

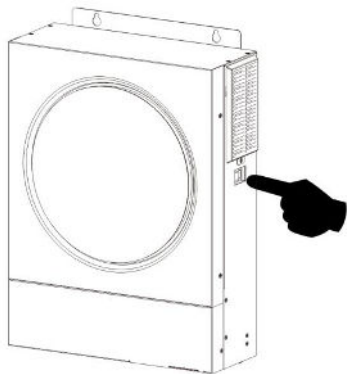

Step 5. Be sure to select battery type as "PYL" in LCD program 5.

05



If communication between the inverter and battery is successful, the battery icon  on LCD display will flash. Generally speaking, it will take longer than 1 minute to establish communication.

WECO

Step 1. Use a custom-made RJ45 cable to connect inverter and Lithium battery.

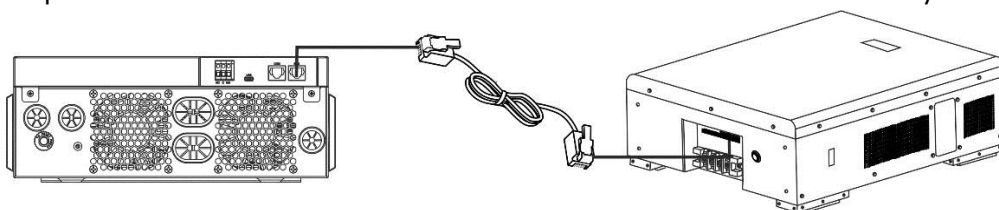

Step 2. Switch on Lithium battery.

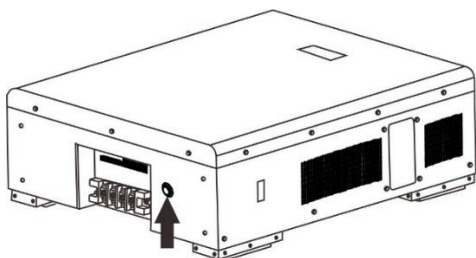

Step 3. Turn on the inverter.

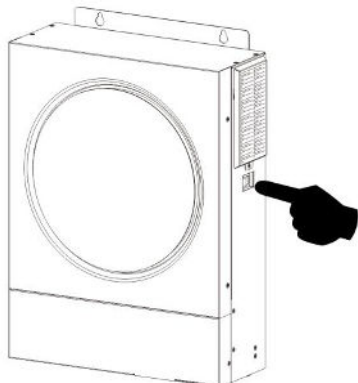

Step 4. Be sure to select battery type as "WEC" in LCD program 5.

05



If communication between the inverter and battery is successful, the battery icon  on LCD display will "flash". Generally speaking, it will take longer than 1 minute to establish communication.

SOLTARO

Step 1. Use a custom-made RJ45 cable to connect inverter and Lithium battery.

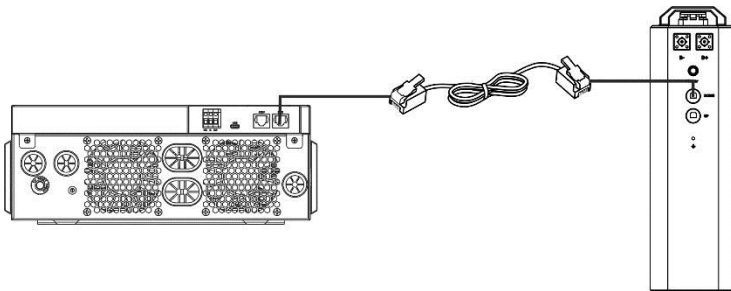

Step 2. Open DC isolator and switch on Lithium battery.

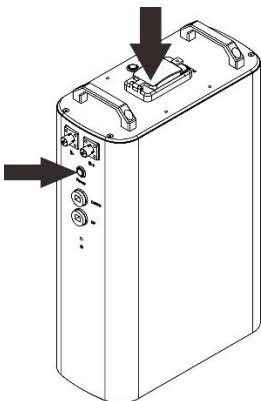

Step 3. Turn on the inverter.

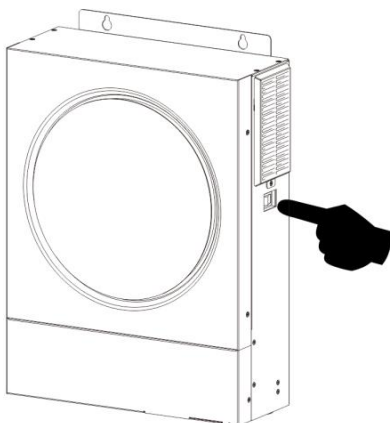

Step 4. Be sure to select battery type as "SOL" in LCD program 5.

05



If communication between the inverter and battery is successful, the battery icon  on LCD display will "flash". Generally speaking, it will take longer than 1 minute to establish communication.

Active Function

This function is to activate lithium battery automatically while commissioning. After battery wiring and commissioning is successfully, if battery is not detected, the inverter will automatically activate battery if the inverter is powered on.



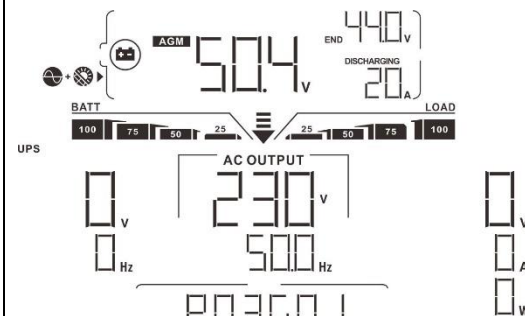

4. LCD Display Information

Press "▲" or "▼" button to switch LCD display information. It will show battery pack and battery group number before "Main CPU version checking" as shown below.

Selectable information	LCD display
Battery pack numbers & Battery group numbers	<p>Battery pack numbers = 3, battery group numbers = 1</p> 

5. Code Reference

Related information code will be displayed on LCD screen. Please check inverter LCD screen for the operation.

Code	Description
60 	If battery status is not allowed to charge and discharge after the communication between the inverter and battery is successful, it will show code 60 to stop charging and discharging battery.
61 	<p>Communication lost (only available when the battery type is not setting as "AGM", "Flooded" or "User-Defined".)</p> <ul style="list-style-type: none"> After battery is connected, communication signal is not detected for 3 minutes, buzzer will beep. After 10 minutes, inverter will stop charging and discharging to lithium battery. Communication lost occurs after the inverter and battery is connected successfully, buzzer beeps immediately.
69 	If battery status is not allowed to charge after the communication between the inverter and battery is successful, it will show code 69 to stop charging battery.
70 	If battery status must to be charged after the communication between the inverter and battery is successful, it will show code 70 to charge battery.
71 	If battery status is not allowed to discharge after the communication between the inverter and battery is successful, it will show code 71 to stop discharging battery.

Appendix II: The Wi-Fi Operation Guide

1. Introduction

Wi-Fi module can enable wireless communication between off-grid inverters and monitoring platform. Users have complete and remote monitoring and controlling experience for inverters when combining Wi-Fi module with WatchPower APP, available for both iOS and Android based device. All data loggers and parameters are saved in iCloud.

The major functions of this APP:

- Delivers device status during normal operation.
- Allows to configure device setting after installation.
- Notifies users when a warning or alarm occurs.
- Allows users to query inverter history data.

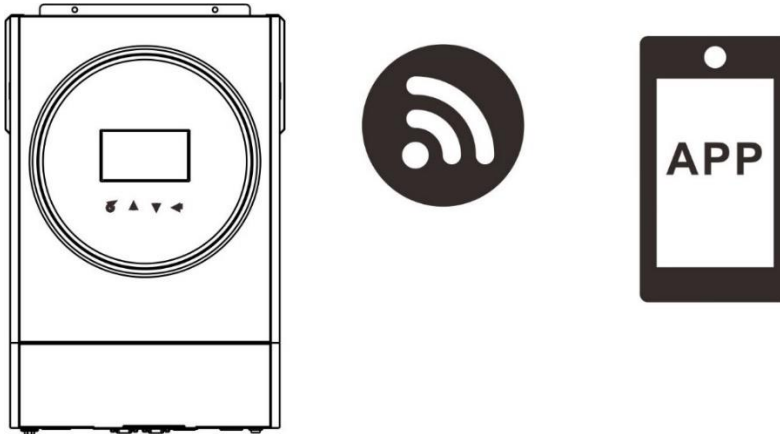

2. WatchPower App

2-1. Download and install APP

Operating system requirement for your smart phone:

🍏 iOS system supports iOS 9.0 and above

🤖 Android system supports Android 5.0 and above

Please scan the following QR code with your smart phone and download WatchPower App.



Android system



iOS system

Or you may find "WatchPower" app from the Apple® Store or "WatchPower Wi-Fi" in Google® Play Store.



2-2. Initial Setup

Step 1: Registration at first time

After the installation, please tap the shortcut icon  to access this APP on your mobile screen. In the screen, tap "Register" to access "User Registration" page. Fill in all required information and scan the Wi-Fi module PN by tapping  icon. Or you can simply enter PN directly. Then, tap "Register" button.



Don't have an account? Please [Register](#)

Then, a "Registration success" window will pop up. Tap "Go now" to continue setting local Wi-Fi network connection.

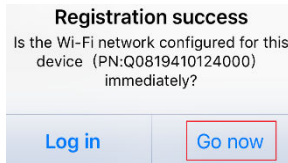

Step 2: Local Wi-Fi Module Configuration

Now, you are in "Wi-Fi Config" page. There are detailed setup procedure listed in "How to connect?" section and you may follow it to connect Wi-Fi.

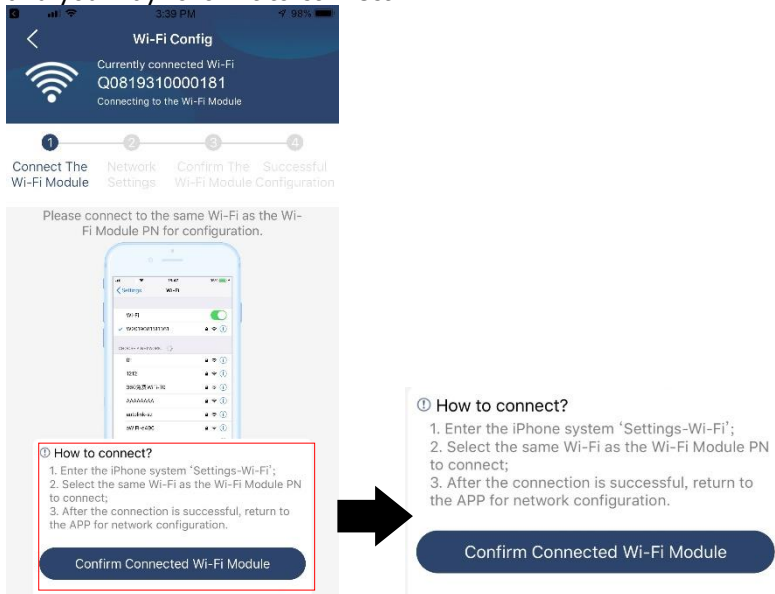

Enter the "Settings→Wi-Fi" and select connected Wi-Fi name. The connected Wi-Fi name is the same to your Wi-Fi PN number and enter default password "12345678".

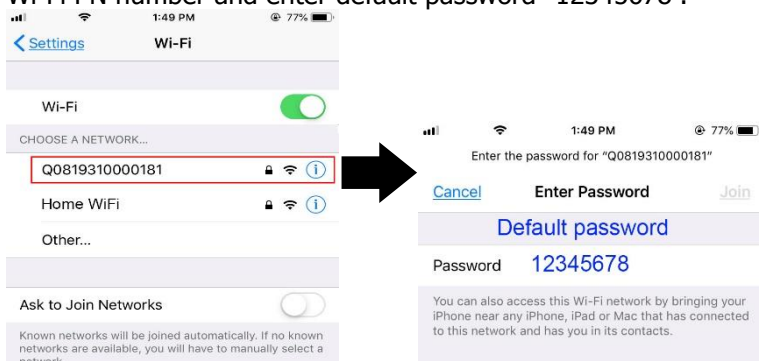

Then, return to WatchPower APP and tap "  " button when Wi-Fi module is connected successfully.

Step 3: Wi-Fi Network settings

Tap  icon to select your local Wi-Fi router name (to access the internet) and enter password.

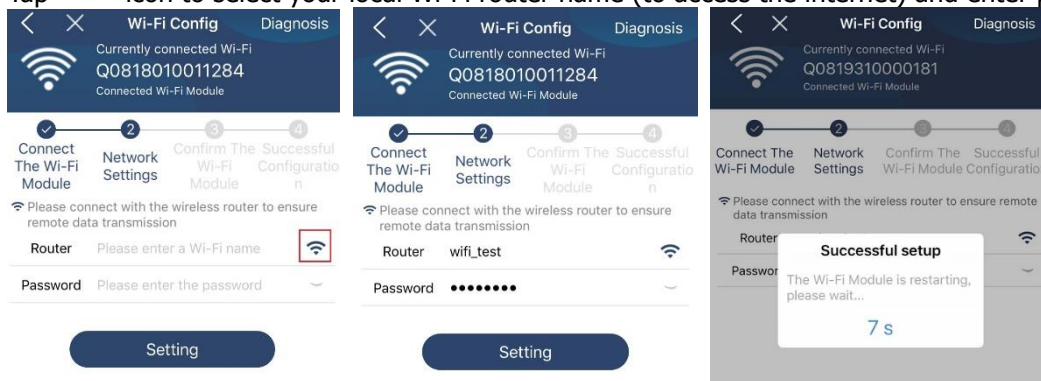

Step 4: Tap "Confirm" to complete the Wi-Fi configuration between the Wi-Fi module and the Internet.

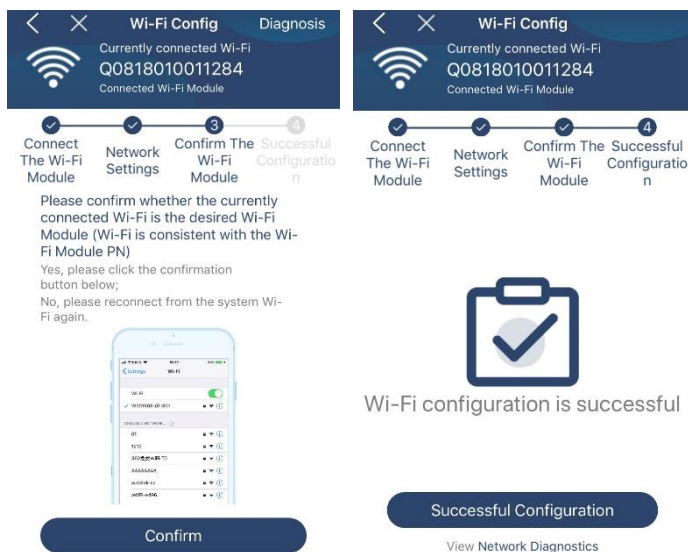

If the connection fails, please repeat Step 2 and 3.

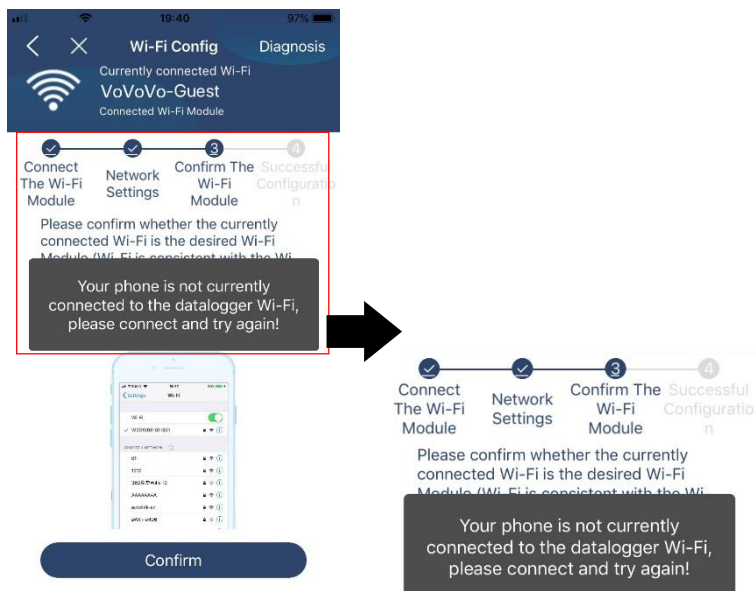

Diagnose Function

If the module is not monitoring properly, please tap "Diagnosis" on the top right corner of the screen for further details. It will show repair suggestion. Please follow it to fix the problem. Then, repeat the steps in the chapter 4.2 to re-set network setting. After all setting, tap "Rediagnosis" to re-connect again.

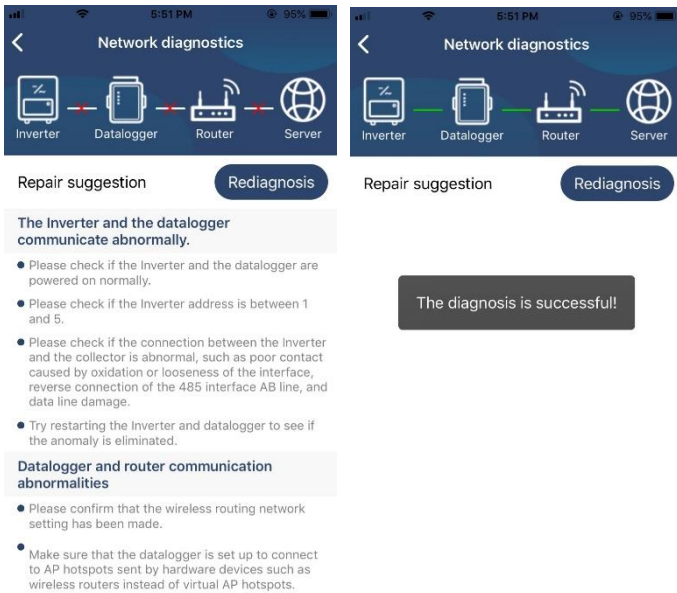

2-3. Login and APP Main Function

After finishing the registration and local Wi-Fi configuration, enter registered name and password to login.
 Note: Tick "Remember Me" for your login convenience afterwards.

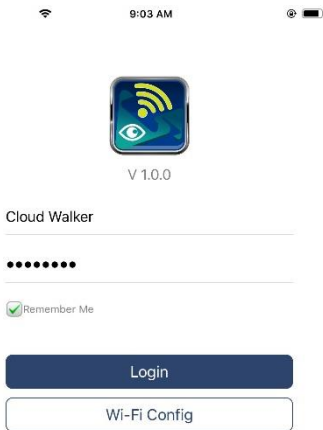

Overview

After login is successfully, you can access "Overview" page to have overview of your monitoring devices, including overall operation situation and Energy information for Current power and Today power as below diagram.

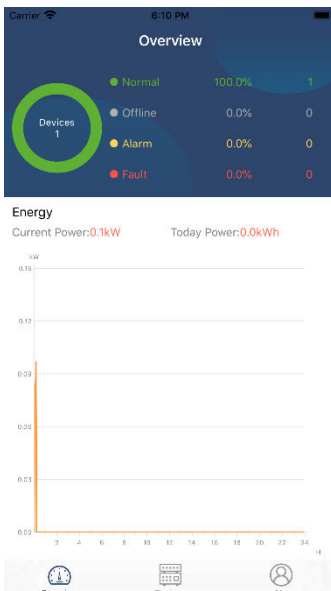

Devices

Tap the  icon (located on the bottom) to enter Device List page. You can review all devices here by adding or deleting Wi-Fi Module in this page.

Add device

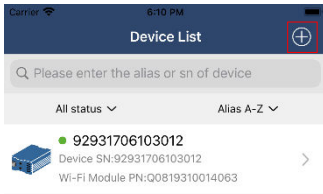

Delete device

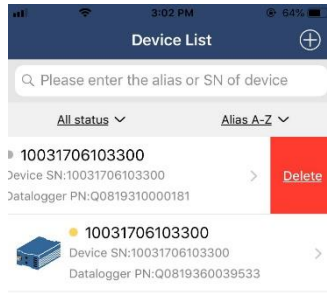

Tap  icon on the top right corner and manually enter part number to add device. This part number label is pasted on the bottom of inverter. After entering part number, tap "Confirm" to add this device in the Device list.

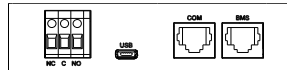
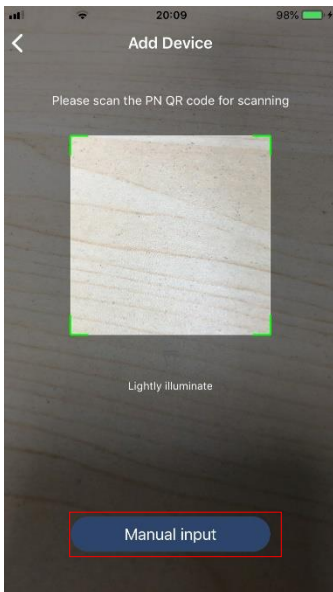

Part number label is pasted on the bottom of inverter.

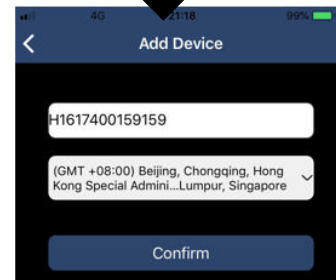
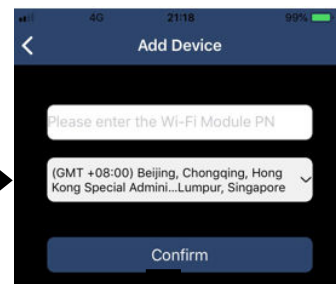

For more information about Device List, please refer to the section 2.4.

ME

In ME page, users can modify "My information", including **【User's Photo】**, **【Account security】**, **【Modify password】**, **【Clear cache】**, and **【Log-out】**, shown as below diagrams.

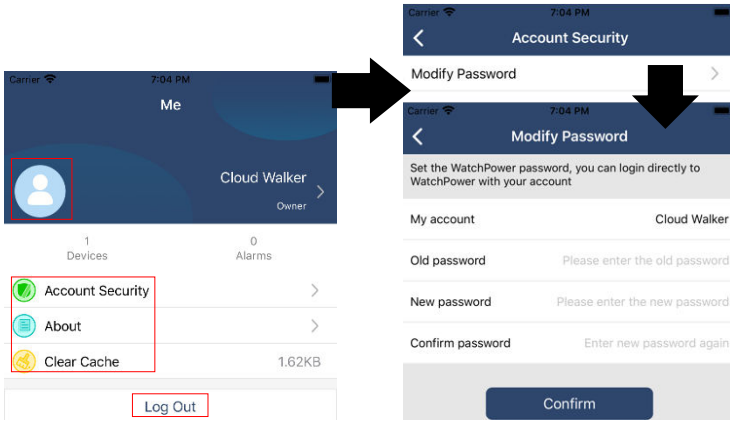

2-4. Device List

In Device List page, you can pull down to refresh the device information and then tap any device you want to check up for its real-time status and related information as well as to change parameter settings. Please refer to the parameter setting list.

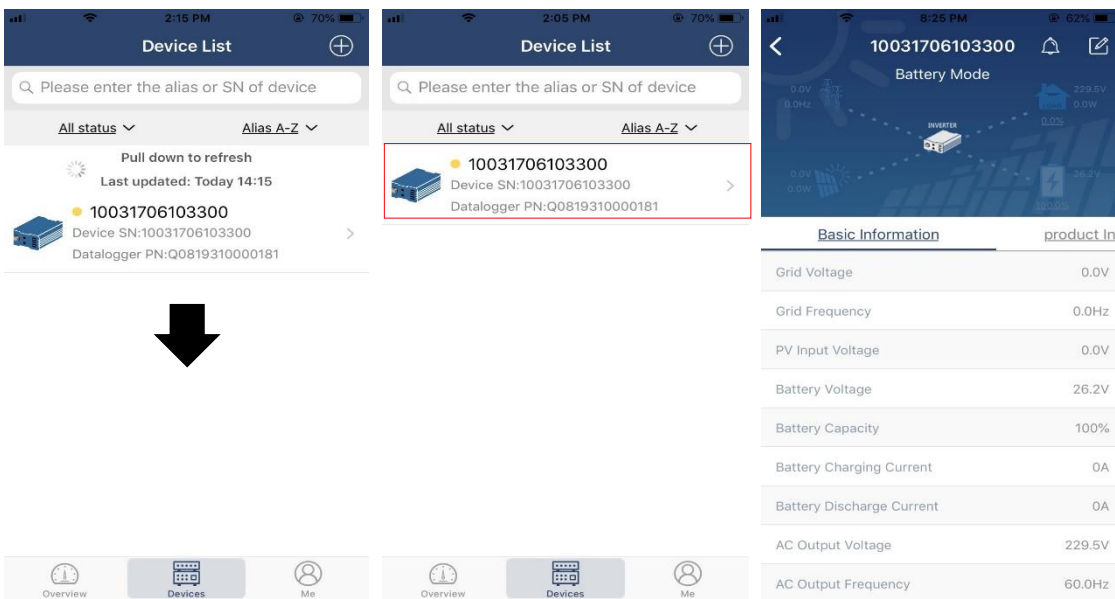

Device Mode

On the top of screen, there is a dynamic power flow chart to show live operation. It contains five icons to present PV power, inverter, load, utility and battery. Based on your inverter model status, there will be **【Standby Mode】** , **【Line Mode】** , **【Battery Mode】** .

【Standby Mode】 Inverter will not power the load until "ON" switch is pressed. Qualified utility or PV source can charge battery in standby mode.

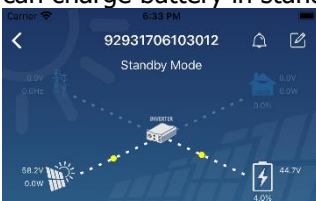

【Line Mode】 Inverter will power the load from the utility with or without PV charging. Qualified utility or PV source can charge battery.



【Battery Mode】 Inverter will power the load from the batter with or without PV charging. Only PV source can charge battery.



Device Alarm and Name Modification

In this page, tap the  icon on the top right corner to enter the device alarm page. Then, you can review alarm history and detailed information. Tap the  icon on the top right corner, a blank input box will pop out. Then, you can edit the name for your device and tap "Confirm" to complete name modification.

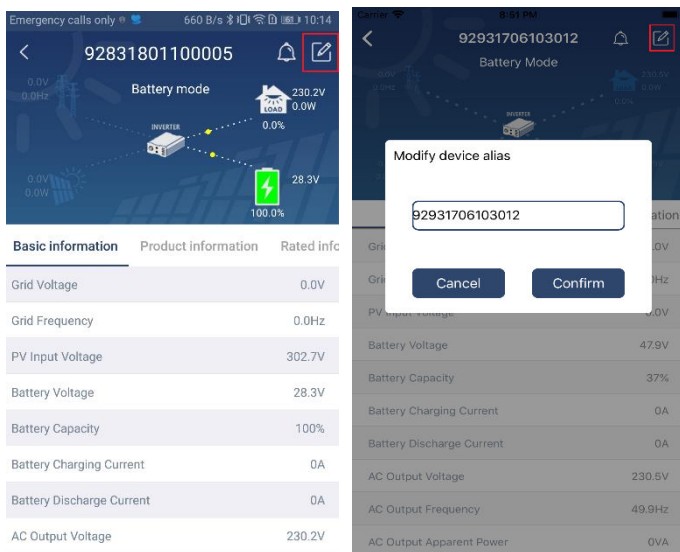

Device Information Data

Users can check up **【Basic Information】** , **【Product Information】** , **【Rated information】** , **【History】** , and **【Wi-Fi Module Information】** by swiping left.

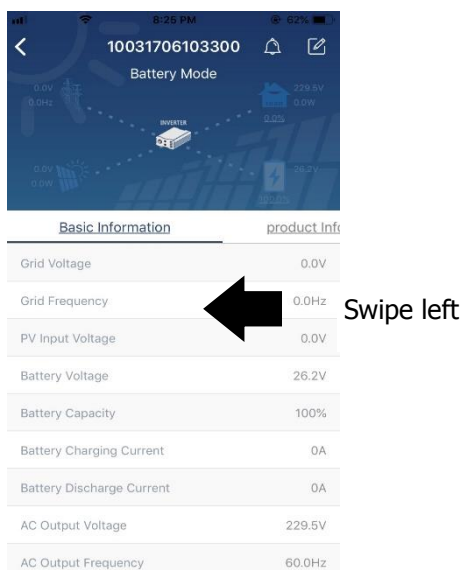

【Basic Information】 displays basic information of the inverter, including AC voltage, AC frequency, PV input voltage, Battery voltage, Battery capacity, Charging current, Output voltage, Output frequency, Output apparent power, Output active power and Load percent. Please slide up to see more basic information.

【Production Information】 displays Model type (Inverter type), Main CPU version, Bluetooth CPU version and secondary CPU version.

【Rated Information】 displays information of Nominal AC voltage, Nominal AC current, Rated battery voltage, Nominal output voltage, Nominal output frequency, Nominal output current, Nominal output apparent power and Nominal output active power. Please slide up to see more rated information.

【History】 displays the record of unit information and setting timely.

【Wi-Fi Module Information】 displays of Wi-Fi Module PN, status and firmware version.

Parameter Setting

This page is to activate some features and set up parameters for inverters. Please be noted that the listing in "Parameter Setting" page in below diagram may differ from the models of monitored inverter. Here will briefly highlight some of it, **【Output Setting】** , **【Battery Parameter Setting】** , **【Enable/ Disable items】** , **【Restore to the defaults】** to illustrate.

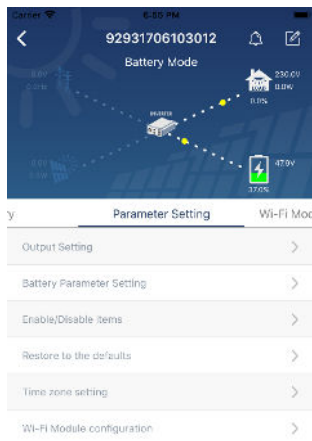

There are three ways to modify setting and they vary according to each parameter.

- a) Listing options to change values by tapping one of it.
- b) Activate/Shut down functions by clicking "Enable" or "Disable" button.
- c) Changing values by clicking arrows or entering the numbers directly in the column.

Each function setting is saved by clicking "Set" button.

Please refer to below parameter setting list for an overall description and be noted that the available parameters may vary depending on different models. Please always see the original product manual for detailed setting instructions.

Parameter setting list:

Item		Description
Output setting	Output source priority	To configure load power source priority.
	AC input range	When selecting "UPS", it's allowed to connect personal computer. Please check product manual for details.
		When selecting "Appliance", it's allowed to connect home appliances.
	Output voltage	To set output voltage.
Output frequency	To set output frequency.	
Battery parameter setting	Battery type:	To set connected battery type.
	Battery cut-off voltage	To set the battery stop discharging voltage. Please see product manual for the recommended voltage range based on connected battery type.
	Back to grid voltage	When "SBU" or "SOL" is set as output source priority and battery voltage is lower than this setting voltage, unit will transfer to line mode and the grid will provide power to load.
	Back to discharge voltage	When "SBU" or "SOL" is set as output source priority and battery voltage is higher than this setting voltage, battery will be allowed to discharge.

	Charger source priority:	To configure charger source priority.
	Max. charging current	It's to set up battery charging parameters. The selectable values in different inverter model may vary. Please see product manual for the details.
	Max. AC charging current:	
	Float charging voltage	
	Bulk charging voltage	It's to set up battery charging parameters. The selectable values in different inverter model may vary. Please see product manual for the details.
	Battery equalization	Enable or disable battery equalization function.
	Real-time Activate Battery Equalization	It's real-time action to activate battery equalization.
	Equalized Time Out	To set up the duration time for battery equalization.
	Equalized Time	To set up the extended time to continue battery equalization.
	Equalization Period	To set up the frequency for battery equalization.
	Equalization Voltage	To set up the battery equalization voltage.
Enable/Disable Functions	LCD Auto-return to Main screen	If enable, LCD screen will return to its main screen after one minute automatically.
	Fault Code Record	If enabled, fault code will be recorded in the inverter when any fault happens.
	Backlight	If disabled, LCD backlight will be off when panel button is not operated for 1 minute.
	Bypass Function	If enabled, unit will transfer to line mode when overload happened in battery mode.
	Beeps while primary source interrupt	If enabled, buzzer will alarm when primary source is abnormal.
	Over Temperature Auto Restart	If disabled, the unit won't be restarted after over-temperature fault is solved.
	Overload Auto Restart	If disabled, the unit won't be restarted after overload occurs.
	Buzzer	If disabled, buzzer won't be on when alarm/fault occurred.
RGB LED Setting	Enable/disable	Turn on or off RGB LEDs
	Brightness	Adjust the lighting brightness
	Speed	Adjust the lighting speed
	Effects	Change the light effects
	Color Selection	Adjust color by setting RGB value
Restore to the default	This function is to restore all settings back to default settings.	

APEX POWER CONCEPTS TRADING LLC

SHOP NO.5 & 6, Seven States building Baniyas Square, Deira, Dubai, United Arab Emirates

Email: info@apexpowerconcepts.com

Mail: P O Box 378542, Dubai, UAE.

Phone: +971-4-2231185